

# BRAVE LITTLE HEARTS

## Affirmations and Activities for Military Kids

Discover Affirmations, Fun Coloring Pages, Thrilling Mazes, Word Searches, Journaling, and more Exciting Activities to Enjoy.

AGES  
4+



By John H Davis  
Author of "365 Days of Veteran Affirmations"

Copyright © 2024 John H. Davis

[www.JohnHDavisWriter.com](http://www.JohnHDavisWriter.com)

Brave Little Hearts: Affirmations and Activities for Military Kids

Ages 4+

All rights reserved.

No part of this publication may be reproduced, distributed, or transmitted in any form or by any means, including photocopying, recording, or other electronic or mechanical methods, without the prior written permission of the publisher or permitted by copyright law.



**This Book  
Belongs To:**

---

---

Two large, empty white rectangular boxes stacked vertically, intended for writing the name of the book owner.

# Maze Fun !

Guide the tank to find its way to the forest.

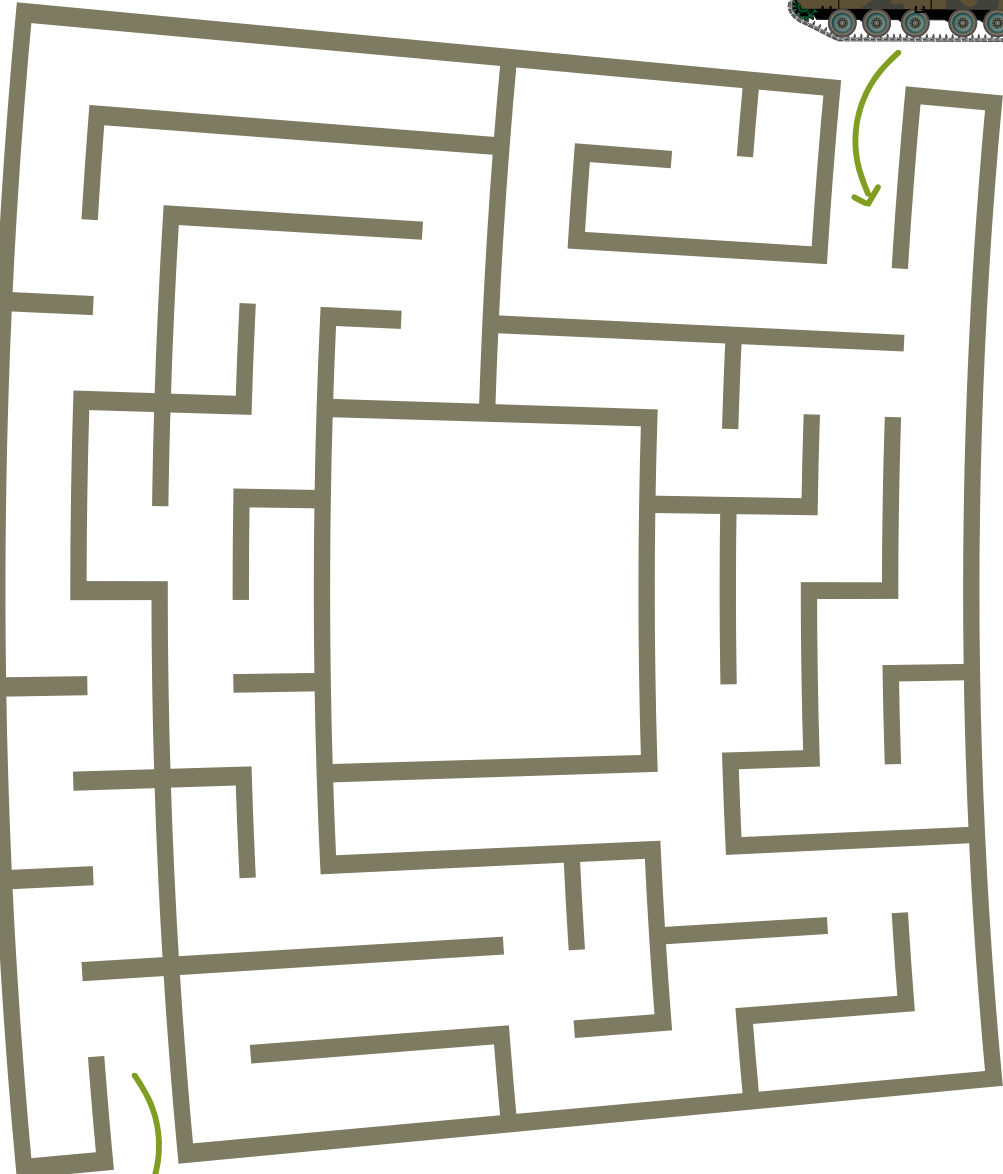
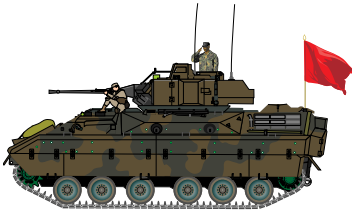

## Coloring Fun !

Color the picture while reading the affirmation aloud!

My hero is a force for  
good in the world, I'll  
be a force for good  
too.

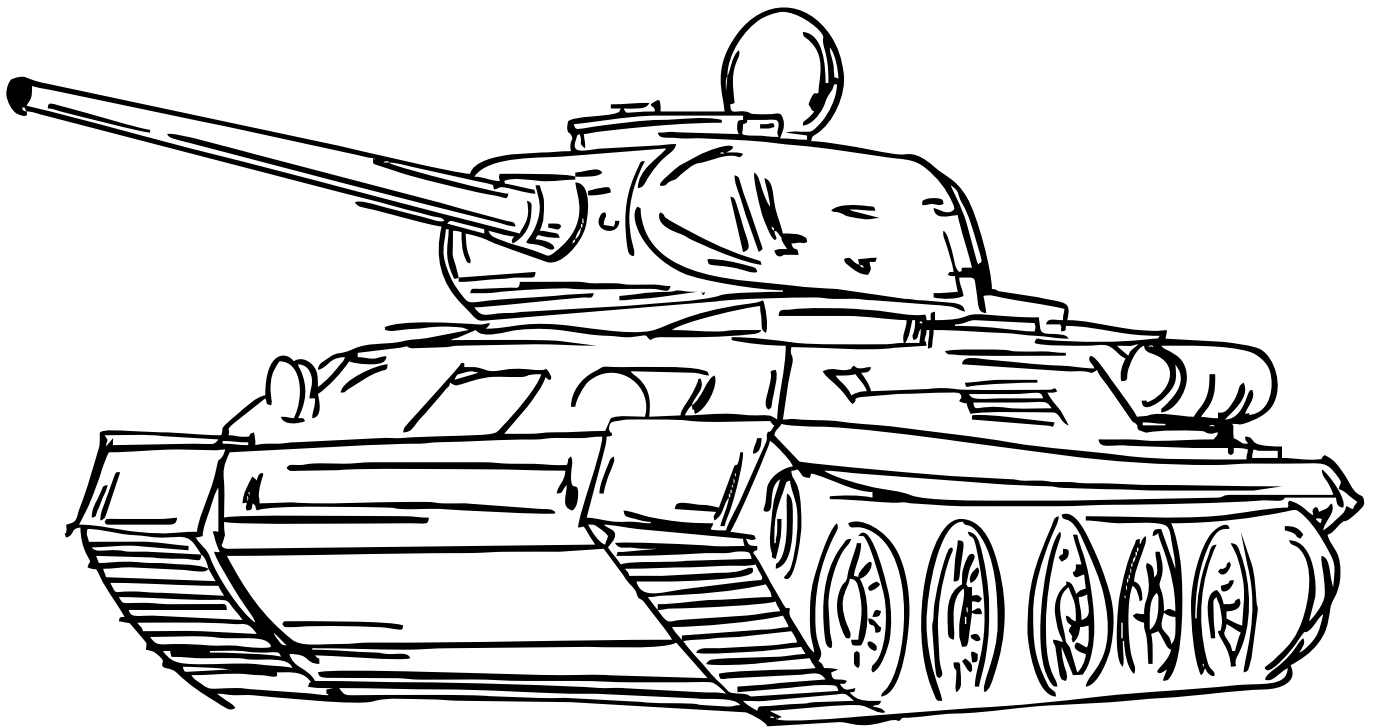

## Coloring Fun !

Color the picture while reading the affirmation aloud!

Our family is the  
strength of the nation.



# Word Search

Circle the hidden words in the puzzle below!

Y V C N Q S Q N I S H O Y S A V J J M Z N B H X T  
Q A R N J G Q D S K T C E T G F A H Q G J D L Q U  
X M Z E D W Q A R D T S C B U N I E Y L S J S T S  
F O D N C Y N U R Y H W H O R G U O Z S W J H A P  
K Y T E R O X D H T E G G L B G K S X N G A V N Z  
F B X B H Q N A Y O I O Z A T G I R I T X F I A Q  
T J O S H C B N U V N L T R W U M G R E N A D E A  
O E B X H D Z U A J X T L Y Q W Q P V W C P F L R  
K R P K O Y E G K I E N X E C T N R P A K Z Z E T  
B Q Q H O I B G T I S H V R R Z X Q B R I O L R B  
G H B G E Z O A Q J F S F O Z Y A E P F N Q Z E O  
O K A H D B E C R F K E A O F W T E S A J D O S J  
E B T O P H V W I R X R L N F F H I M R N L A B Z  
M F T J S B U S F E A O D B C E I F R E C X S I F  
J M A C R T D R O V R C M S L E T B B R F S E H U  
W F L J X U O V L P T B K N D U S H D L P G H C H  
Z X I U B R I I B B F Q D S R C O D R O L U S K F  
G V O Q C S G W L N I C O U H I Y Q X E S L N S D  
U G N V M O A X J R V E F U W U R J C U K I D S M  
E D N V Z A I S W O H G L N Y B A H P Z A X K T F

## WORD BANK

ARTILLERY

GRENADE

WARFARE

BATTALION

BARRACKS

RECONNAISSANCE

## Coloring Fun !

Color the picture while reading the affirmation aloud!

I will support my hero  
today by being brave.





## Coloring Fun !

Color the picture while reading the affirmation aloud!

Not every day is  
easy, but I'm going  
to try my best  
today.



# Journaling

The biggest challenge I've overcome is....

---

---

---

---

---

---

---

---

---

---

Draw here.

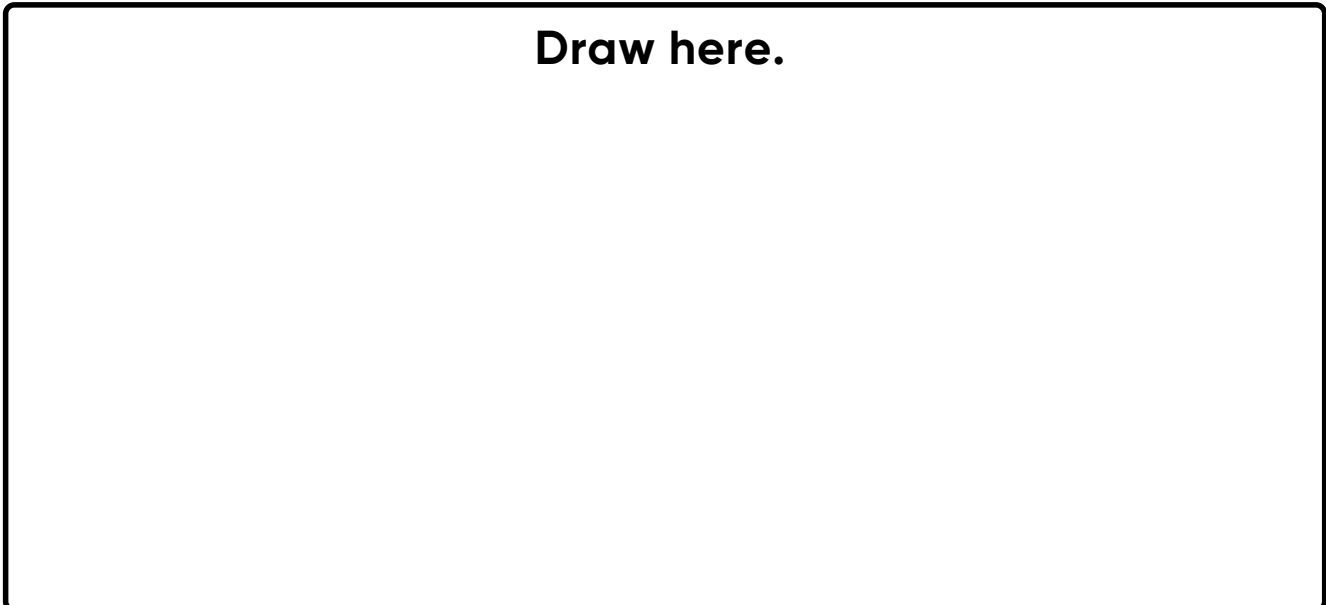

## Coloring Fun !

Color the picture while reading the affirmation aloud!

Everyone I see  
today is protected  
by my hero.

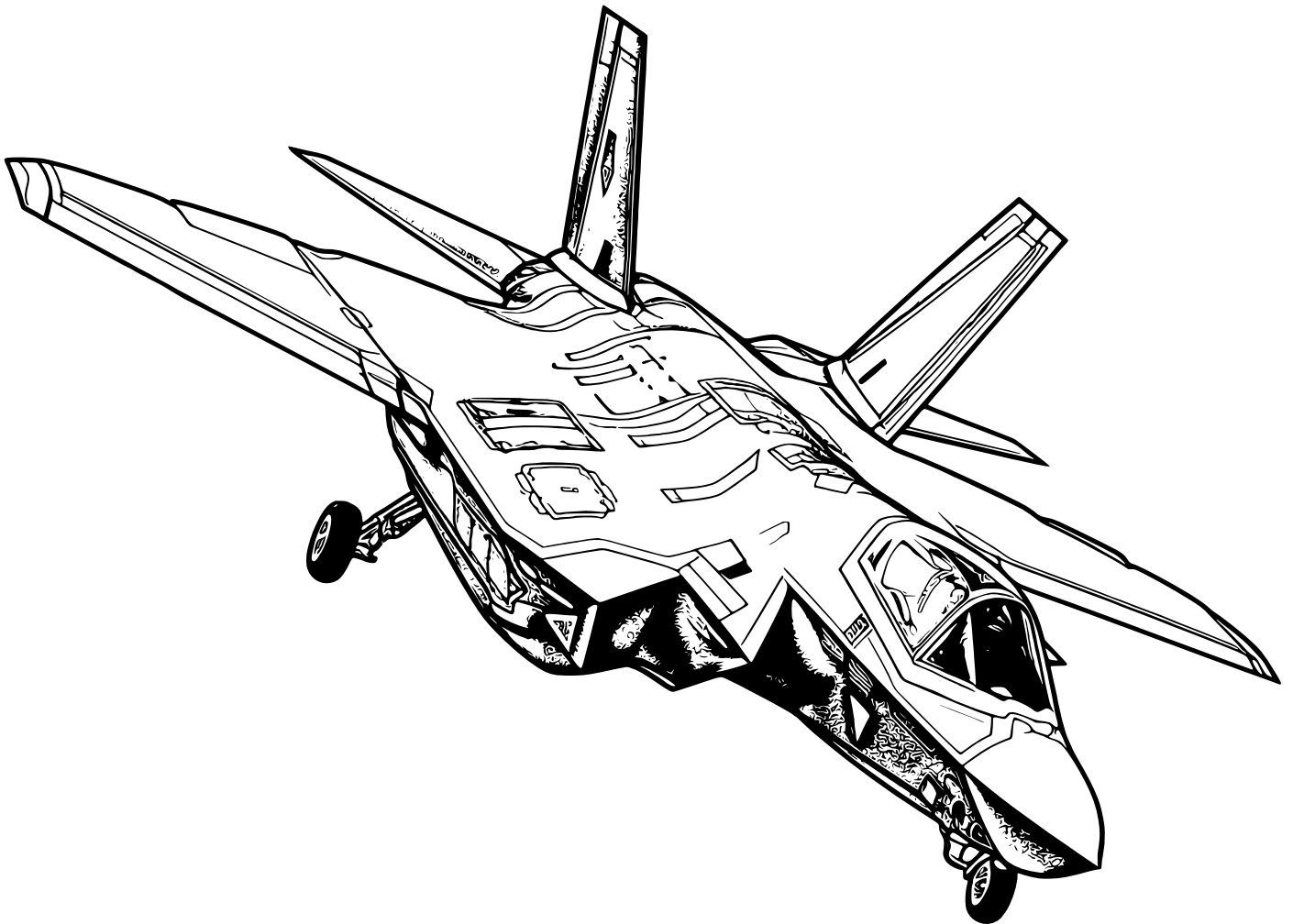

## Coloring Fun !

Color the picture while reading the affirmation aloud!

I'll do a good deed  
today in honor of  
my hero.

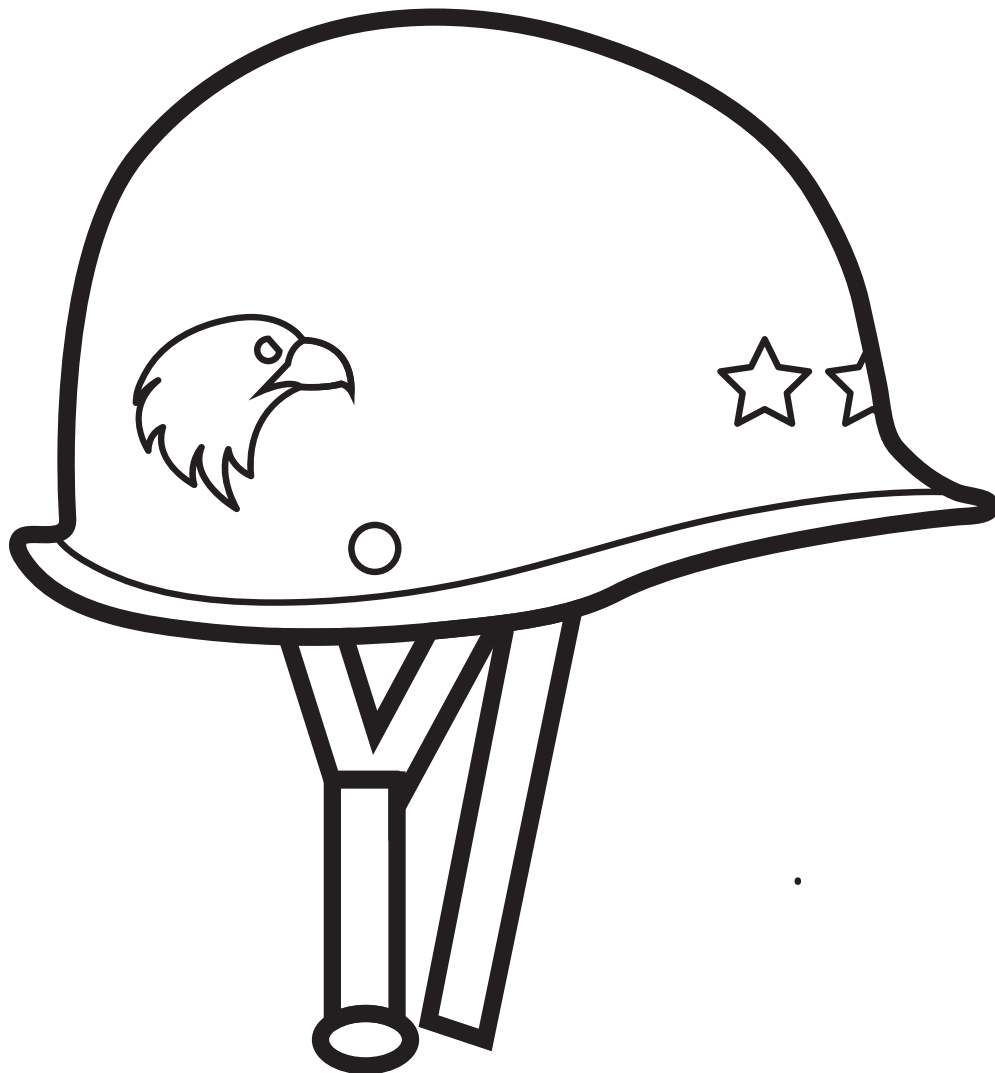

# Maze Fun !

Direct the scout to gather information.

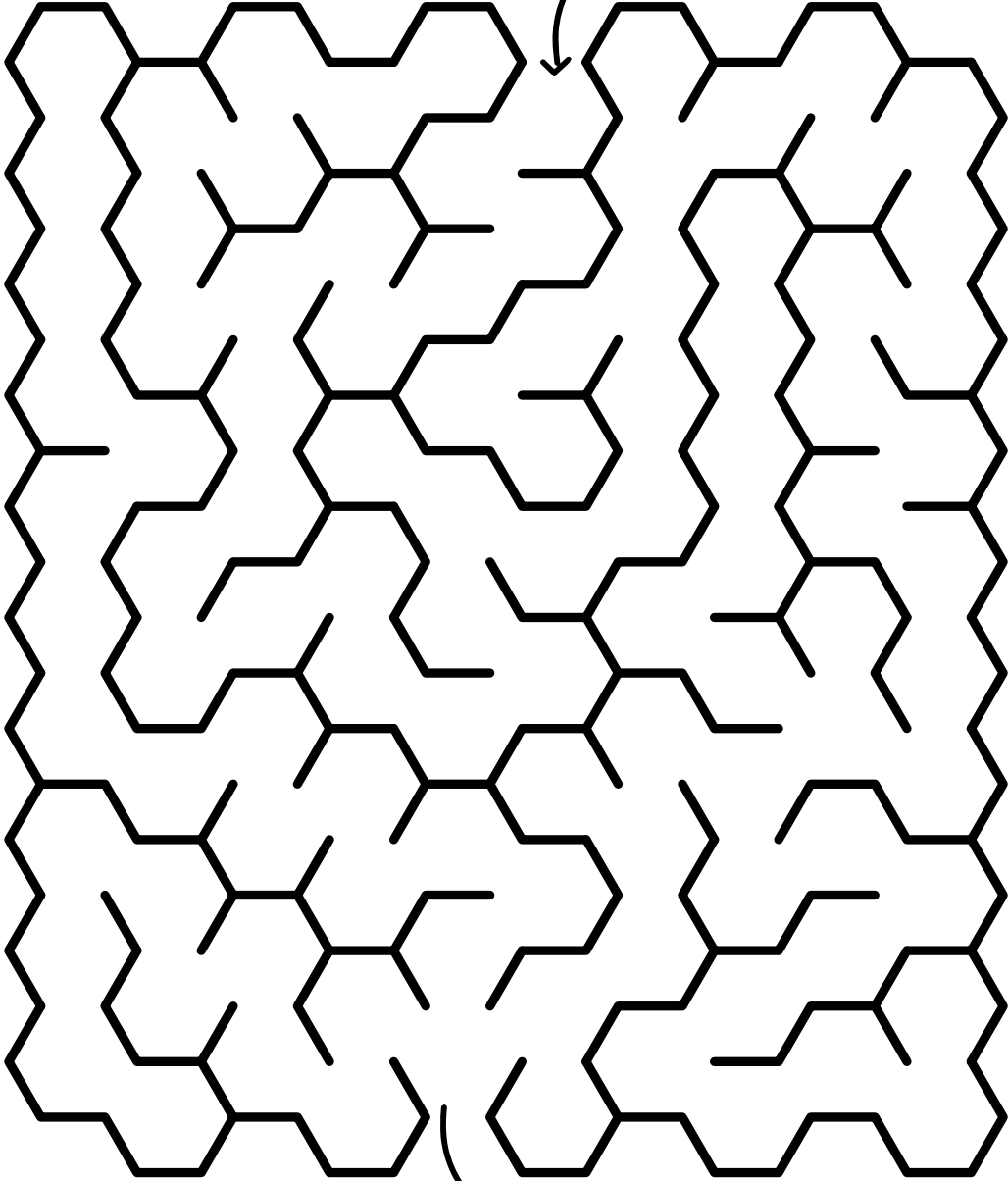

## Coloring Fun !

Color the picture while reading the affirmation aloud!

**Military life can be  
crazy and that's  
okay.**

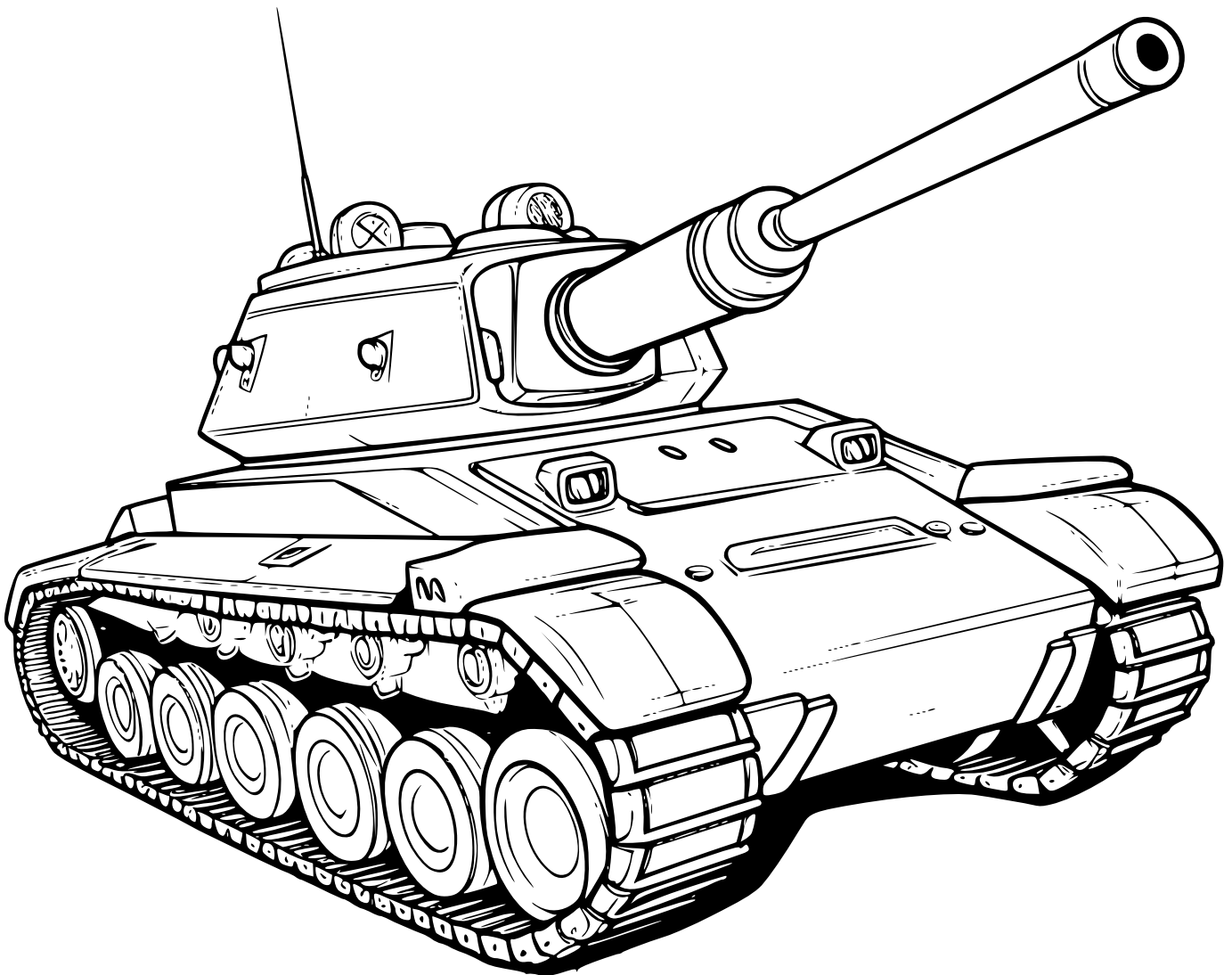

## Coloring Fun !

Color the picture while reading the affirmation aloud!

Our family

is

important,

what we

do

matters.

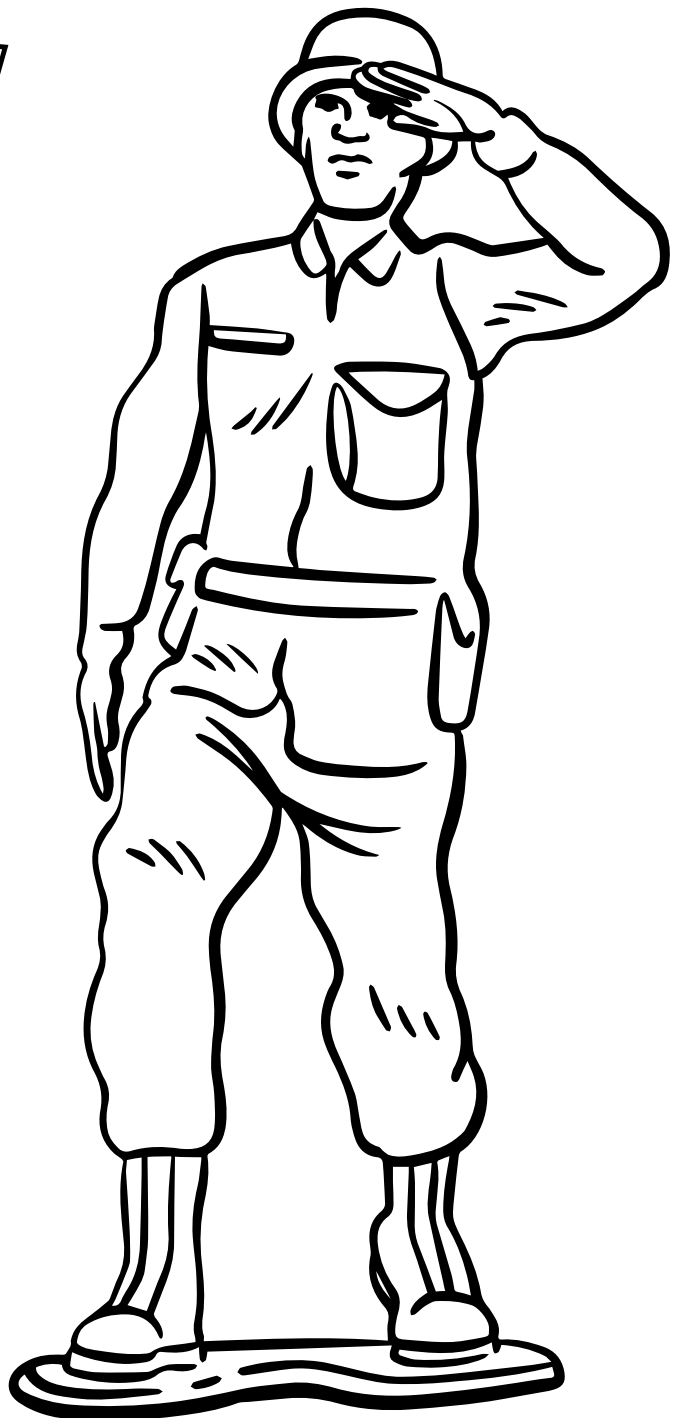

# Word Search

Circle the hidden words in the puzzle below!

Q V N X P J Y E W O K S K K A H G G M N V A Q D I  
J K R V E G C J V F R D F P T J R C X J U V Y F L  
L G U F J F D X A A E T D N V Q B B I R R T N N O  
L S U Q O E E O E A P E L G T V A O J C T U J O H  
Q Z V T X G C B J I C T G O Y W C N Y Z E Z G Q X  
V N J B U Q J F U M C F S F X I O N D Q N S B O S  
Z E Q T D B L A C K H A W K S T M E H F B P X L V  
Y M X M R I R Z S X Y E Z O M T U L H O D R C V G  
J D D G V Q L N P A R A C H U T E N I Q J K S C Z  
E V Z D I W Z X P K C N L E O Q U R G W U C B K Z  
L R X N B Q W M R Y E N L D S A U O C H I N O O K  
J C Y O E F G T Y N C B X S B U B R T K G D C T O  
M F R M O G S Y D X Z T D O W Q D N K S E A V Z O  
V C D I C N W I Q X T G N L B V E O W N O D V C X  
T M I T T F I I Q G M C K D V A O I O I U N U A Q  
Q H D E G L A Y C Z H S E I F F X U V P U J B C J  
T Z C G D C I D E G L K B E R V X E O E W W F U H  
I T Q A M W H U M V N Z U R F P M K K R F R C A Q  
Q G T L X Z R O D N W G E K R Y O R H J O W F H P  
N B R Z K N C S J I I Q D F T G W S A R M O R C X

## WORD BANK

SNIPER

ARMOR

CHINOOK

SOLDIER

BLACKHAWK

PARACHUTE



## Coloring Fun !

Color the picture while reading the affirmation aloud!

Missing my hero is  
normal. I love my  
hero.

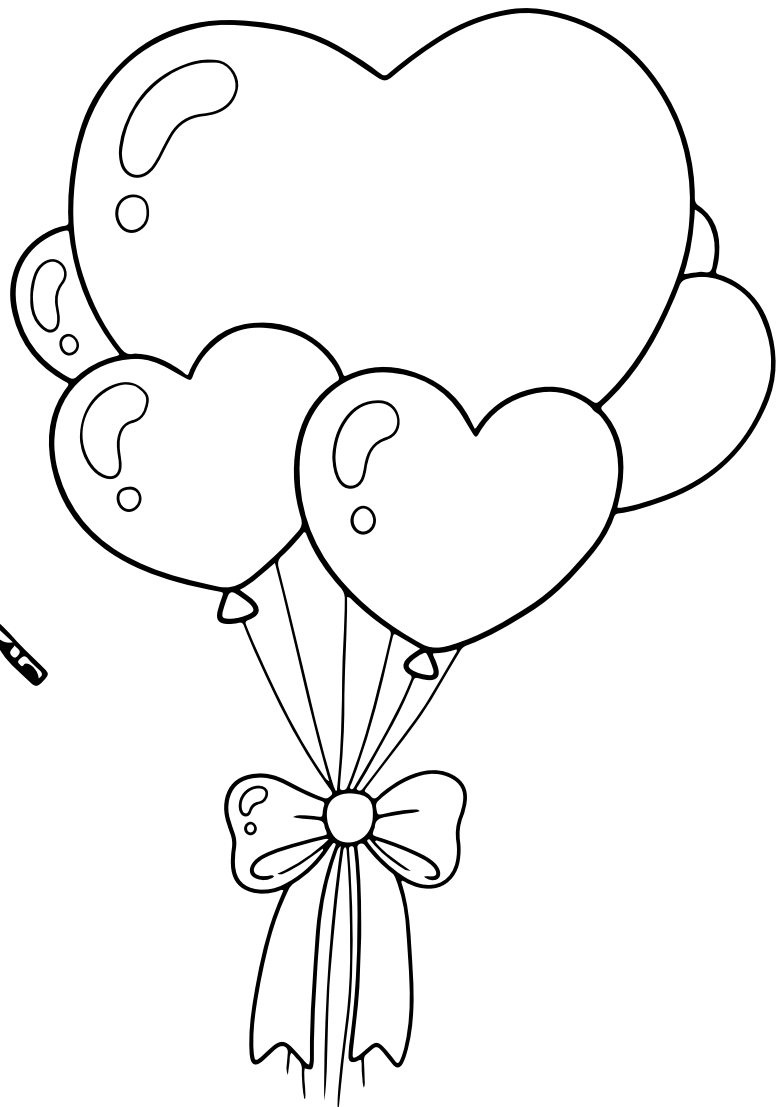

## Coloring Fun !

Color the picture while reading the affirmation aloud!

**My heart is military  
strong, I'm proud  
of myself.**

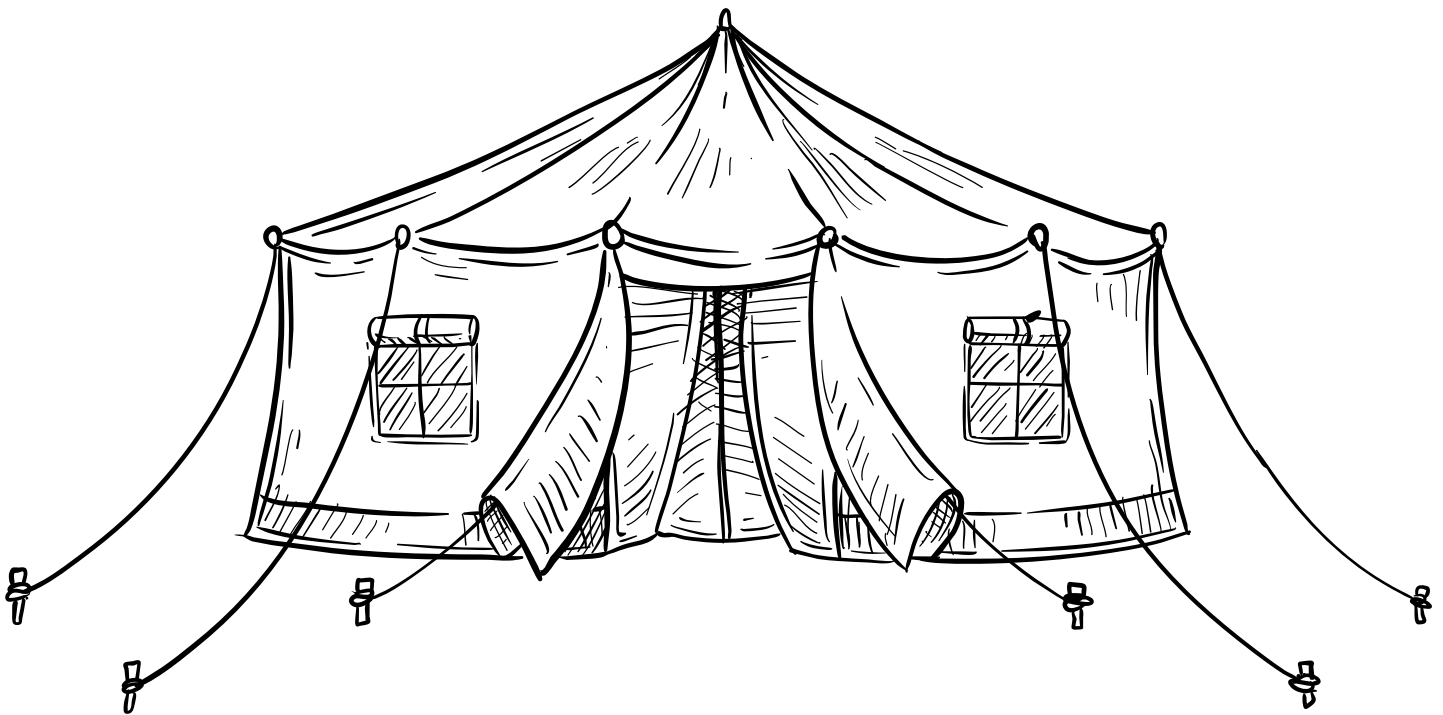

# Journaling

One thing I admire about my hero is.....

---

---

---

---

---

---

---

---

Draw here.

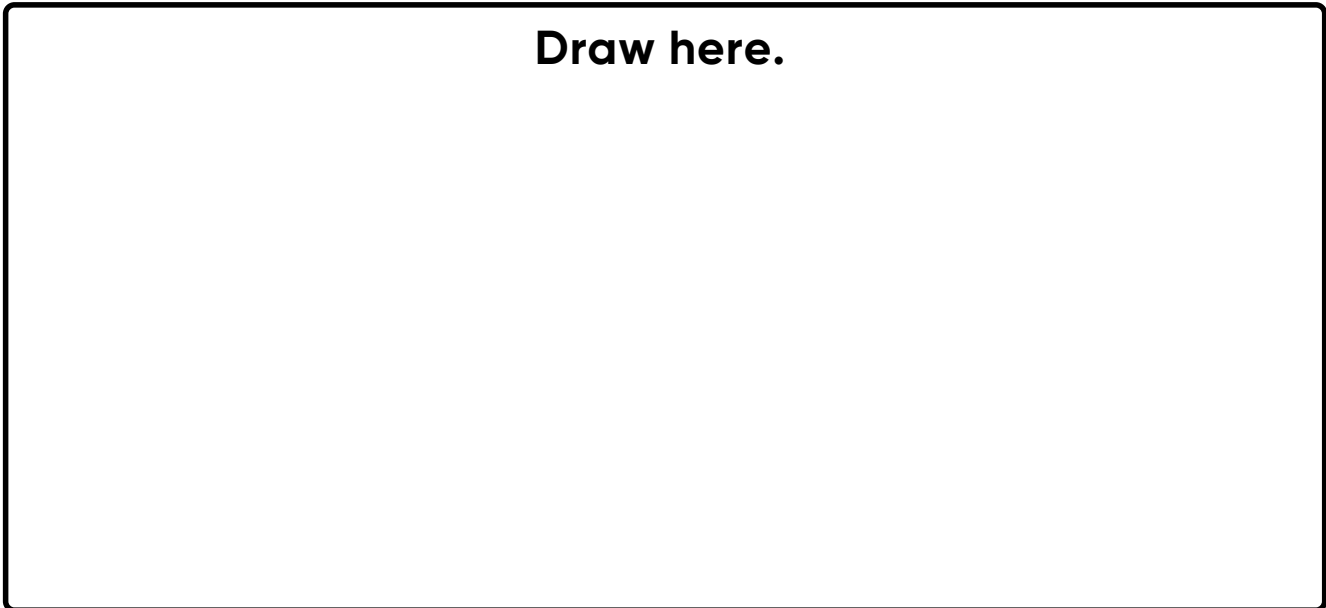

## Coloring Fun !

Color the picture while reading the affirmation aloud!

Our family is a  
team, we're going  
to get through this  
together.

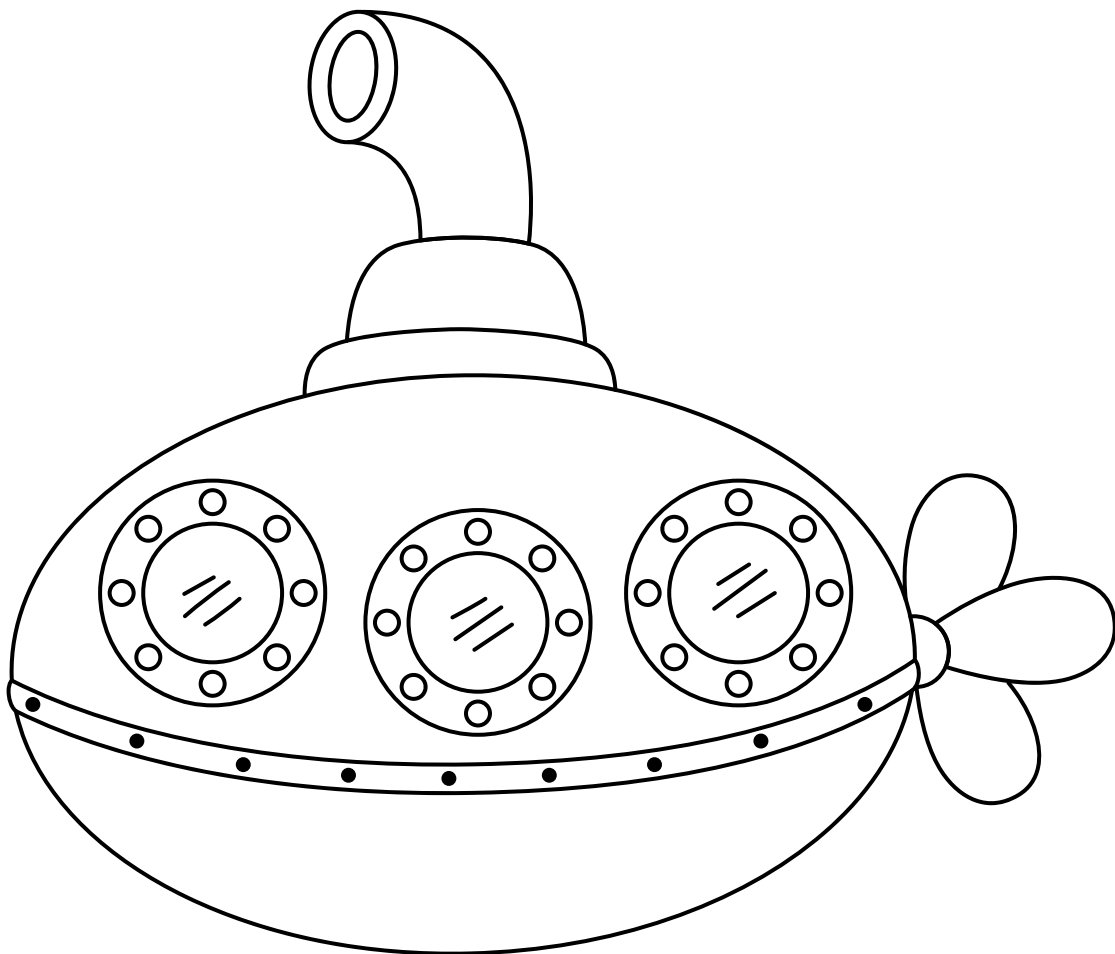

## Coloring Fun !

Color the picture while reading the affirmation aloud!

I appreciate  
military veterans  
like my hero.

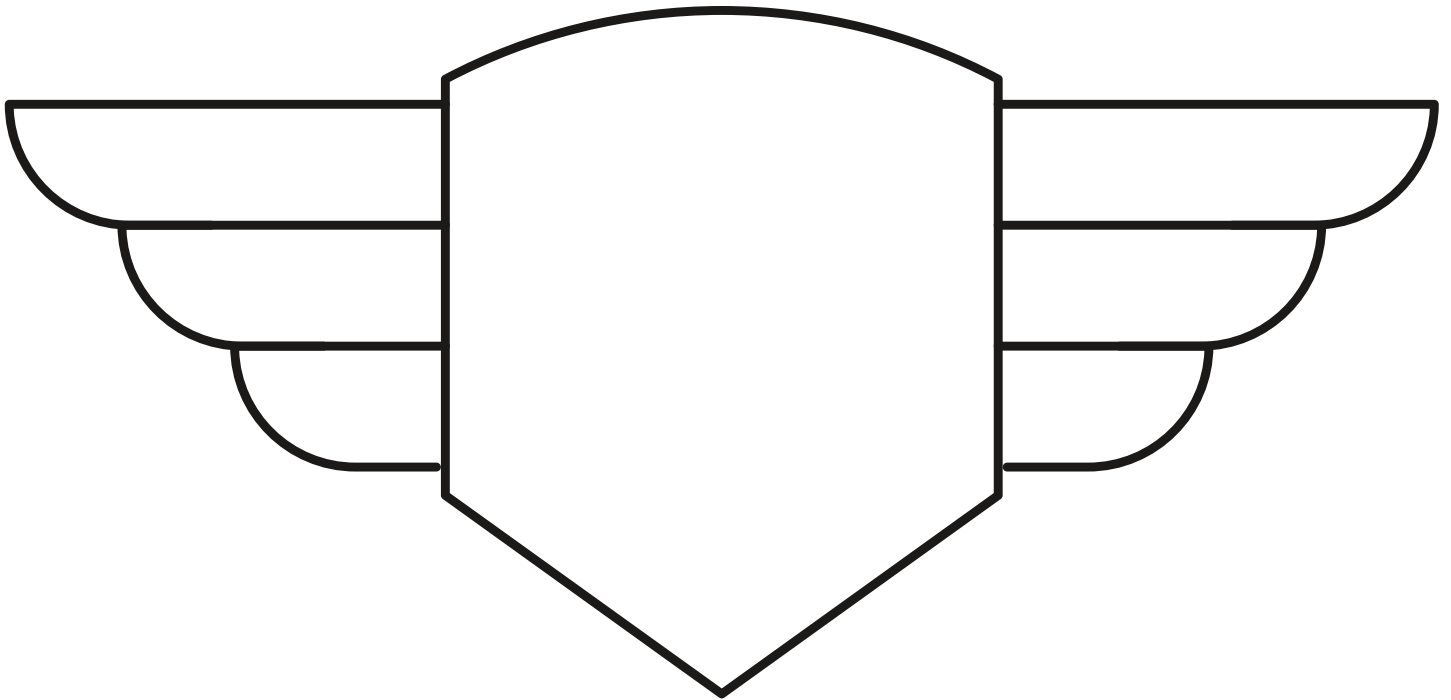

## Coloring Fun !

Color the picture while reading the affirmation aloud!

I am a tank, I am  
unstoppable.

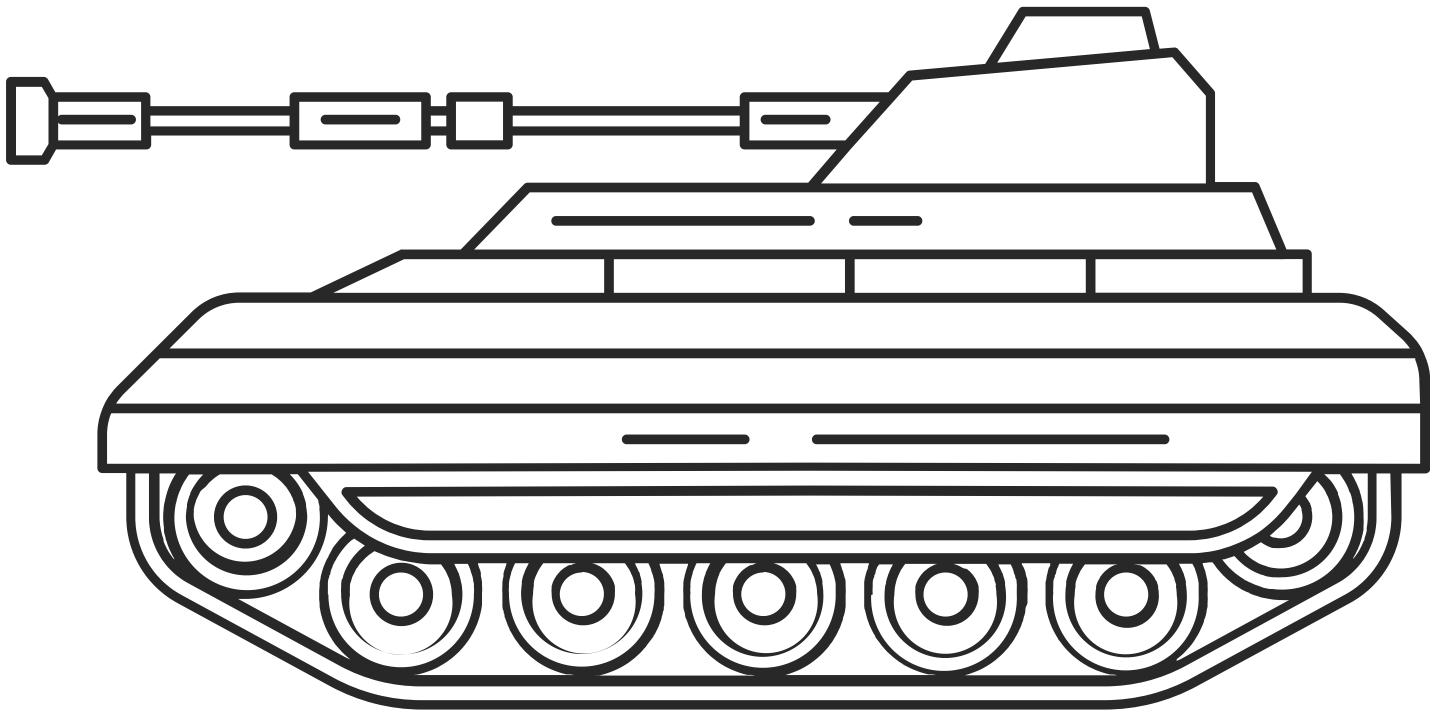

# Maze Fun !

Help the paratrooper land safely.

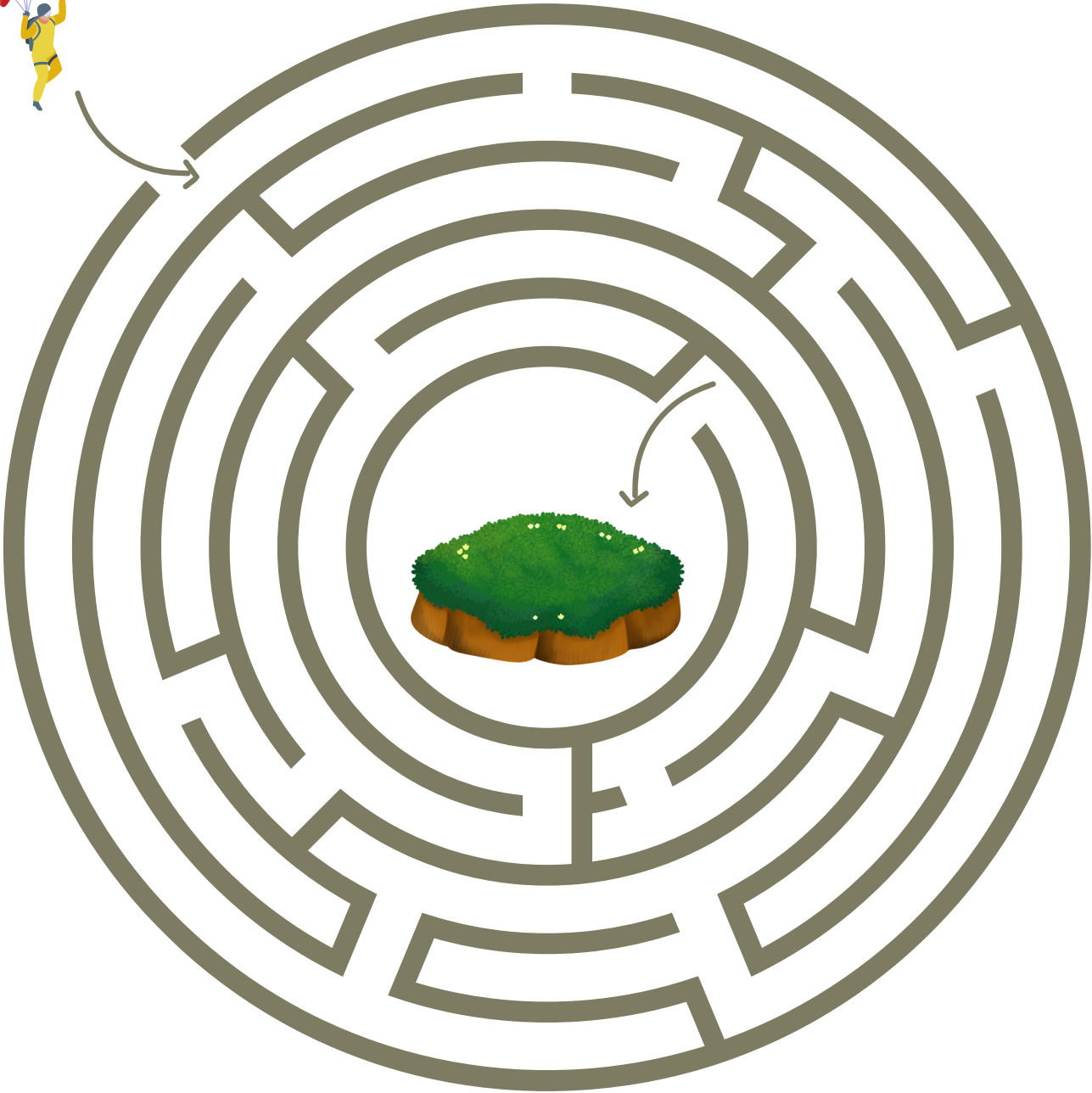
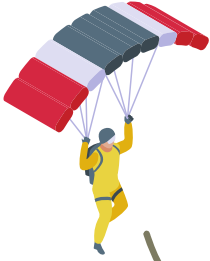

## Coloring Fun !

Color the picture while reading the affirmation aloud!

I can be a leader  
just like my hero.

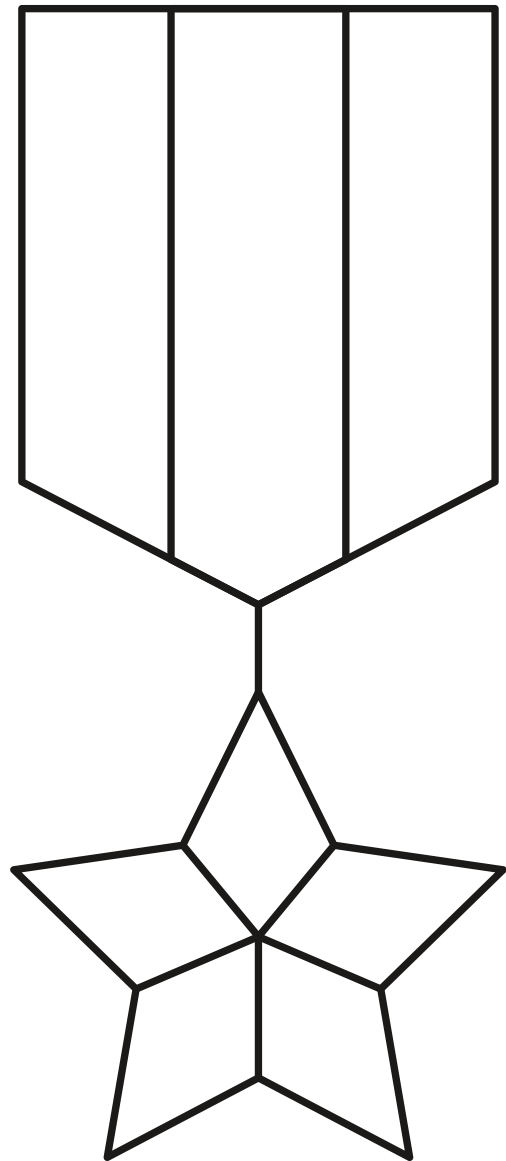
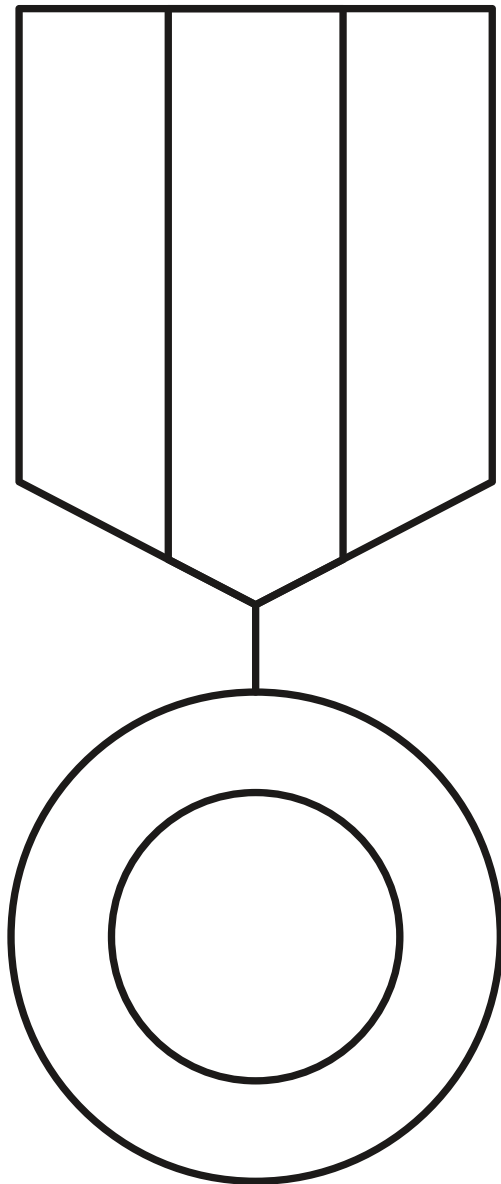



# Word Search

Circle the hidden words in the puzzle below!

J W T G T A I O Z Y L U G X H Z Z T I V C B X K L  
U C C L L M B V U O O Y T D Z C M H R O A I O P X  
M F T G W J O S S I W D D W M L U S Z V I V U Y B  
C R T K I H O B J F B A A N X E Y Y D C R A F V M  
J E P D O A V S R O R X L K P E D T H A C H W Q M  
Z R L K R Q X G P R J O U V F H J I Z O R S A I E  
S S L Y P E N S G T Q Q Q T I J M E C Q A V K Y K  
L T X Q O V H Y R J P M C V A C U N D S F X R X X  
U R O R M K E K L A F G T E F G L X X Y T R X Y L  
Y F I R F F M L N U N I S D V N I G S U D P K C V  
F T Z L P U C R I S Q G J F L B J H V U I G I Q U  
C K R N U E Q G G M R H E P W B R B N R V S N K M  
D B H Y V I D T H G F X J R F J Y P W N B D X I I  
I Q K C G K C O J K S H Y B N N L A S Y W G V R T  
L I N V Y M I K Z O R V L B Z A A D W C R F L Y L  
W Z U O B Q F U Z N W N D L Q V N C L W J M T U N  
J Y J W S K X P N A G S K C Q B H T B M A O T C F  
T N L W Q B A T T L E S H I P K N X G U N O O T L  
C F M H F V B B W T K N G U G I N L X U R W I K M  
L V F K G C I F I S B B U Z Q U L K X W I X F M O

## WORD BANK

FORT

TORPEDO

MEDIC

BATTLESHIP

AIRCRAFT

RANGER

## Coloring Fun !

Color the picture while reading the affirmation aloud!

My hero loves me,  
and I love my hero.

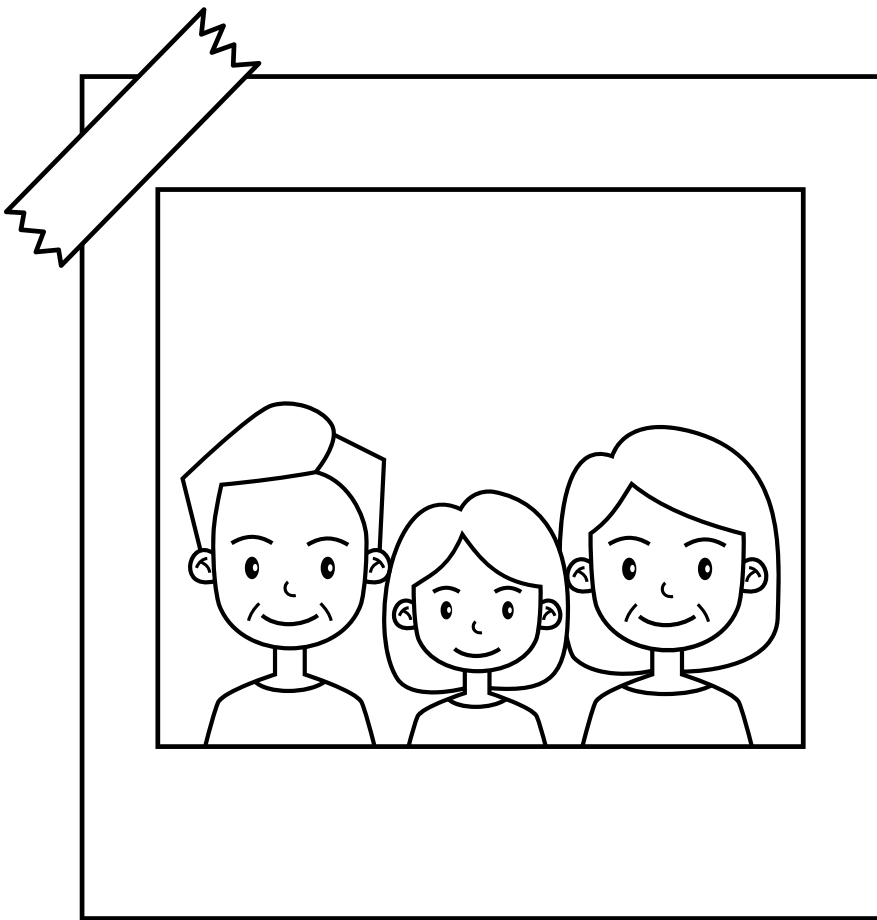

## Coloring Fun !

Color the picture while reading the affirmation aloud!

Protecting people  
takes courage, our  
family has courage.

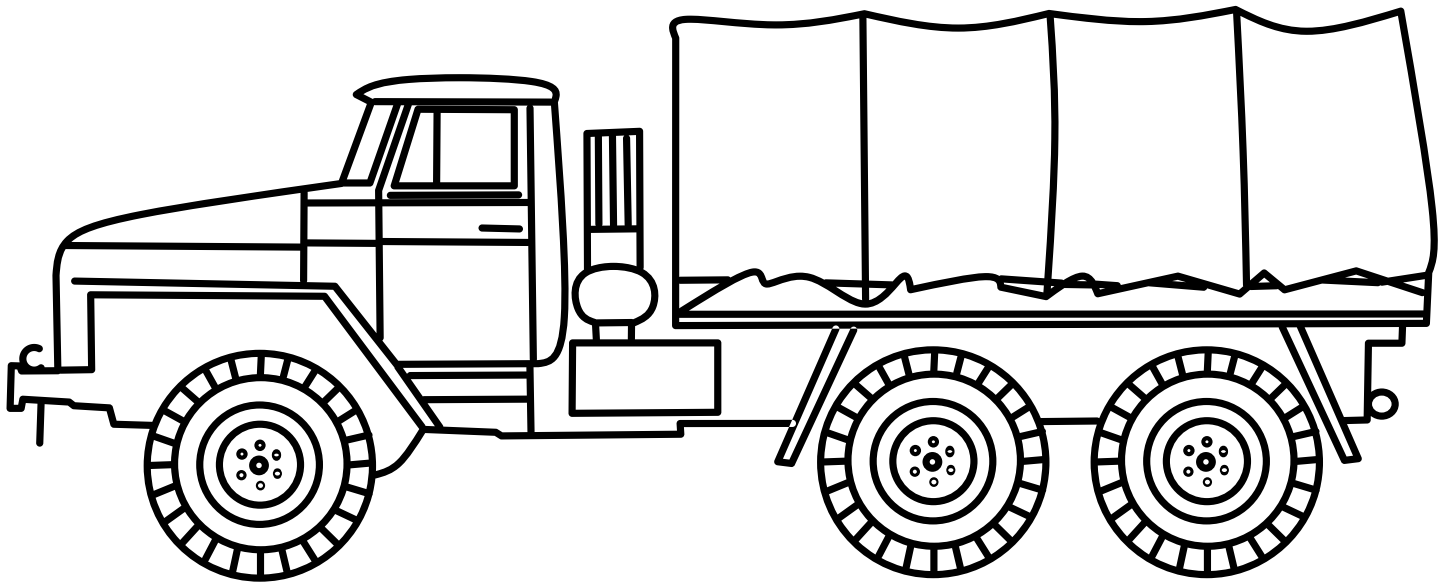

# Journaling

Today, I learned something new, which is...

---

---

---

---

---

---

---

---

Draw here.

## Coloring Fun !

Color the picture while reading the affirmation aloud!

Heroes aren't only  
in movies, I have a  
hero in my family.

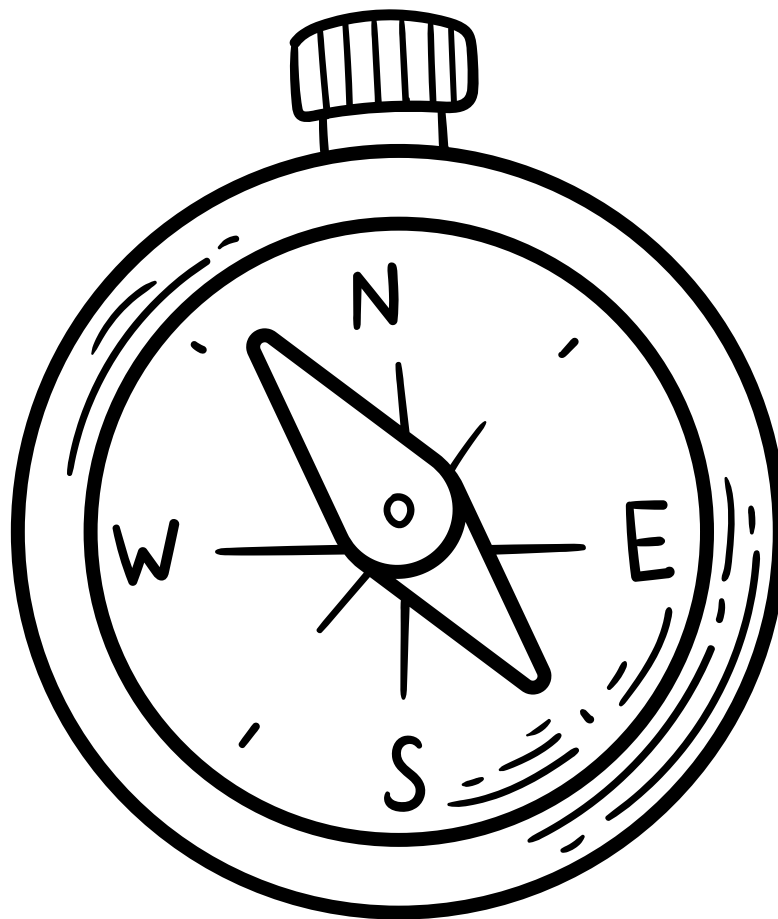

## Coloring Fun !

Color the picture while reading the affirmation aloud!

I am honest and  
powerful.

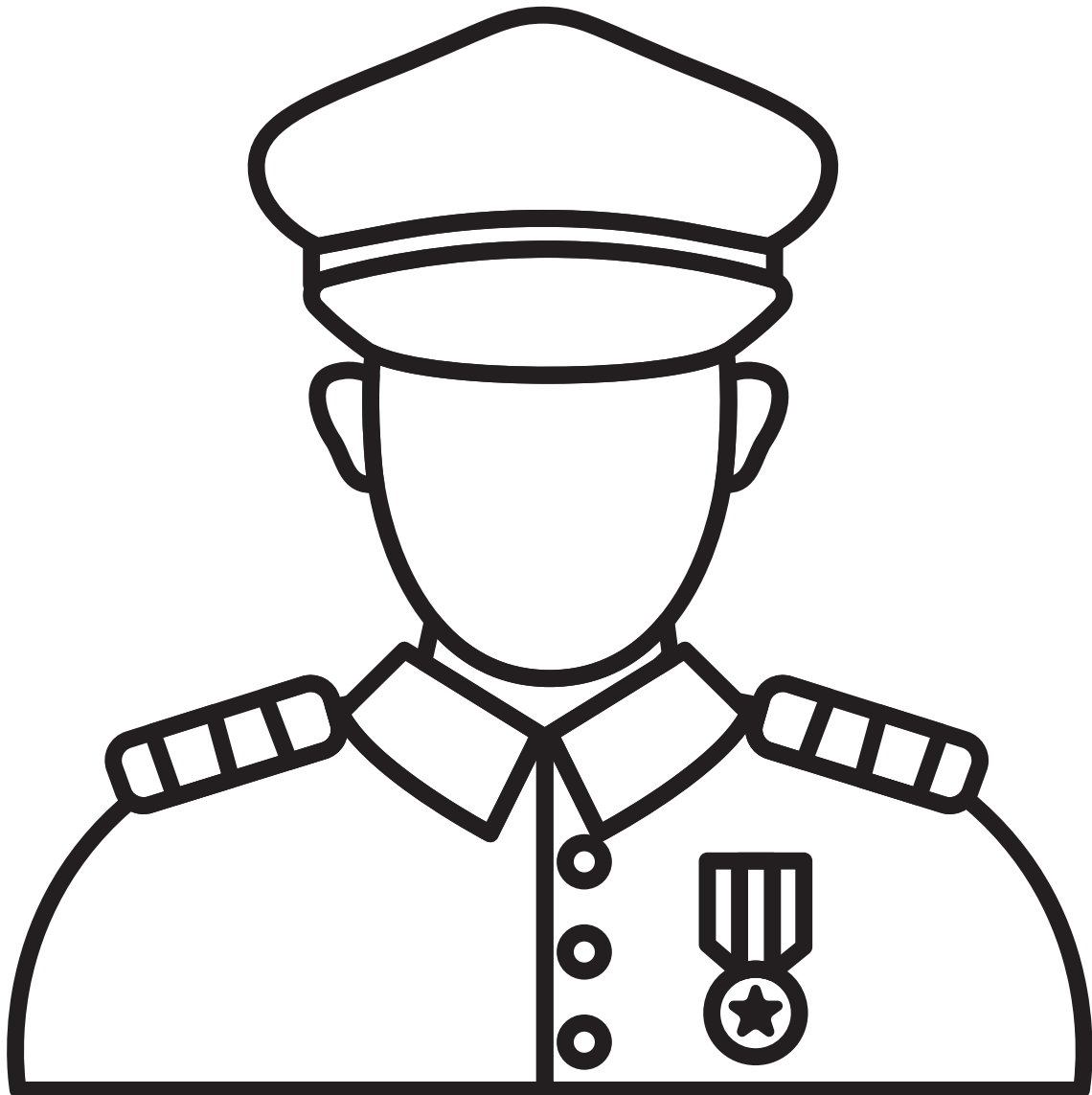

# Maze Fun !

Help the soldier find his way to the aircraft.

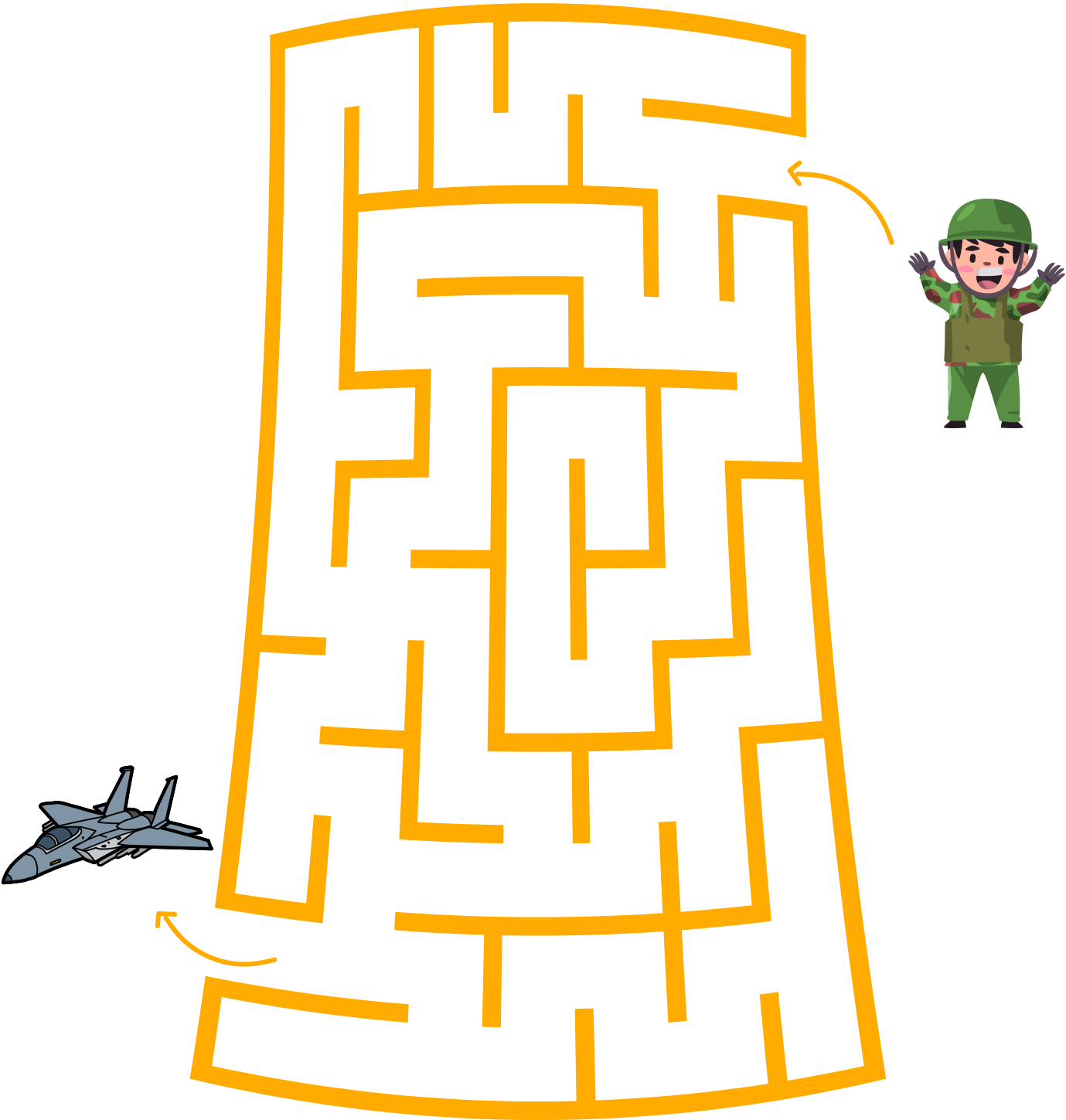

## Coloring Fun !

Color the picture while reading the affirmation aloud!



Patience

isn't

easy,

but

it's

part

of

military

life.



## Coloring Fun !

Color the picture while reading the affirmation aloud!

**My hero loves me  
no matter where  
they are.**

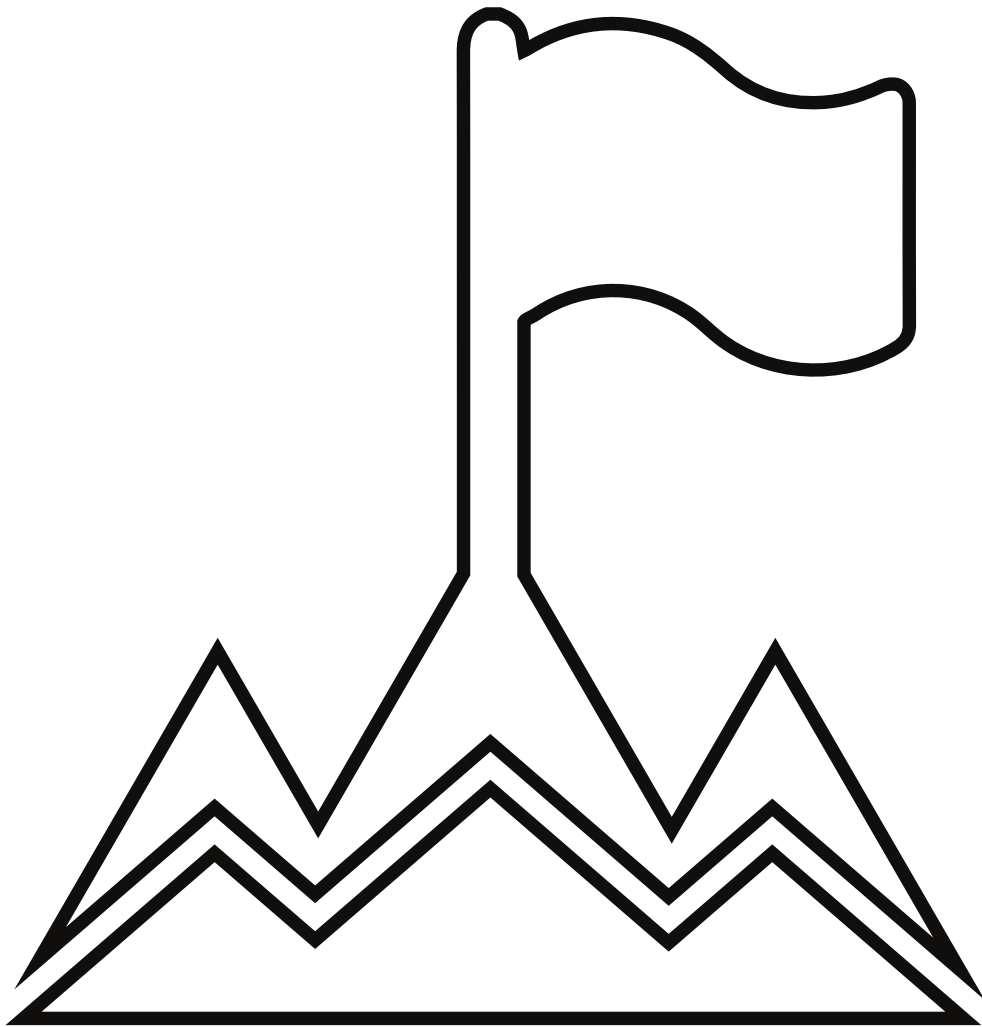

# Word Search

Circle the hidden words in the puzzle below!

W J F Z Z U O O C C M U E T R R E P R E W J H W O  
K U B C G Q R T N Y T J S B V M Y J E C R I I E R  
L T F W Z S Y X B Q O C K C V Q D S H P U A B I P  
O P Q L K U T E A V A B T A H V S H V U Z S D X L  
T O S G R L D R B E G W T M Y W L X T F I F P A T  
C J R U S I B G X K N C O O N V B Y J H C Y M B R  
Q J O M B Y U Q F F U B U U Z H Q L N U Z V B I D  
W B K A U M A X J V F I R F L J V C E E D H Q C A  
G T F K W R A D O L V J N L N I S P M W L H K S V  
I W P N F C G R F R U E I A W N H H Y G Y D S E L  
V L Q V X G P O I E V G Q G P F Y M I G Z A H U A  
S A B T Y N V Z T N J I U E G A L I D K F B X I O  
Y Q Y Y A H X L Y N E N E R T N B T B N C T H U G  
K H A C S E H O C A L Q T V Q T O I O M F V O W E  
F W J F J P A H W Q H G C J Y R V D W Z S I H M N  
L G V X K J N A E N T X V V D Y C A N P H L P Y E  
M I K U J E P D E Q Y A B C F O V D M I P M D F R  
P Z Z T R V T S G R M A J V X F L Z R X C G T L A  
W F E G P R B Y J X H V Q A K K A A D Z J A I A L  
F S T C F I E N L D J C J H V E G R W S K U U N F

## WORD BANK

INFANTRY

RADAR

CAMOUFLAGE

GENERAL

SUBMARINE

TOURNIQUET

## Coloring Fun !

Color the picture while reading the affirmation aloud!

I will fly high like a  
helicopter.



## Coloring Fun !

Color the picture while reading the affirmation aloud!

I can record a  
message for my  
hero, even if they  
aren't here.

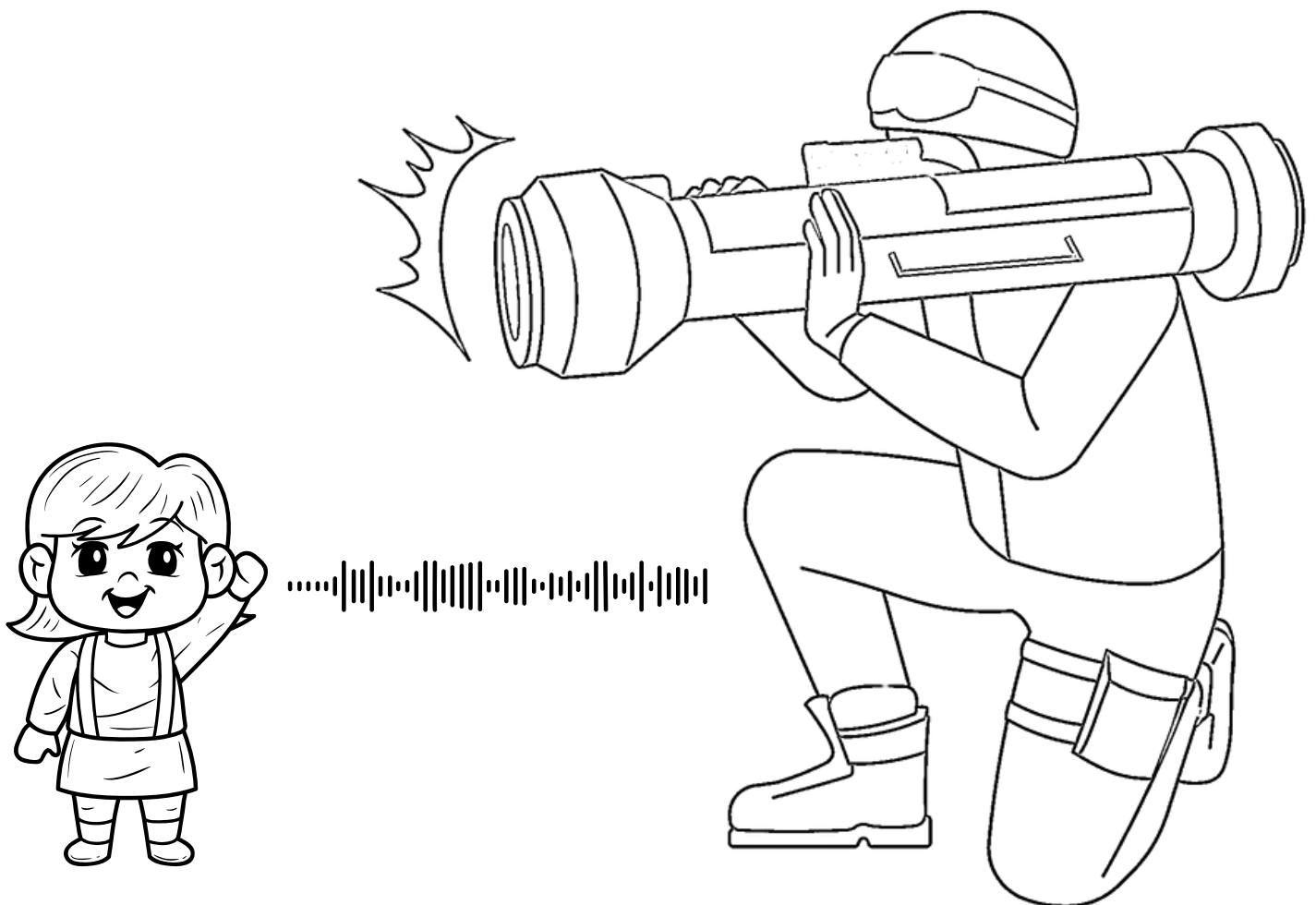

# Journaling

The bravest moment I've witnessed from my hero is...

---

---

---

---

---

---

---

---

---

---

Draw here.

## Coloring Fun !

Color the picture while reading the affirmation aloud!

I eat healthy food  
to make me  
military strong.



## Coloring Fun !

Color the picture while reading the affirmation aloud!

I will work hard at  
school to make my  
hero proud.

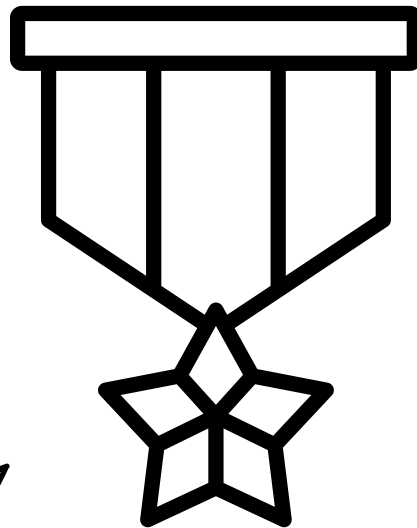

# Maze Fun !

Guide the Jeep to deliver supplies.

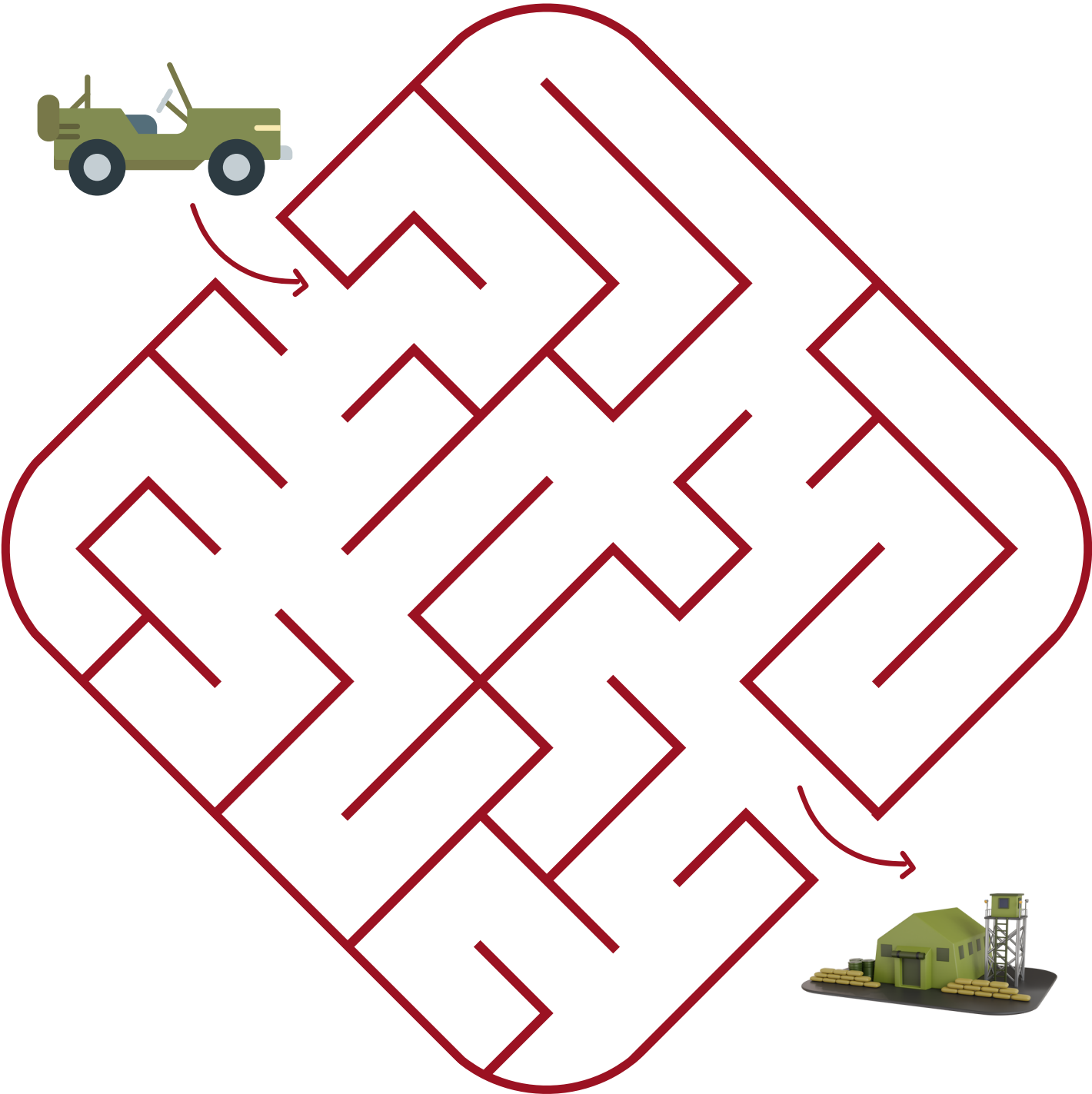
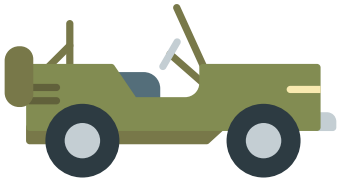



## Coloring Fun !

Color the picture while reading the affirmation aloud!

My hero misses me  
today too.



## Coloring Fun !

Color the picture while reading the affirmation aloud!

I want to be  
mentally tough and  
physically fit

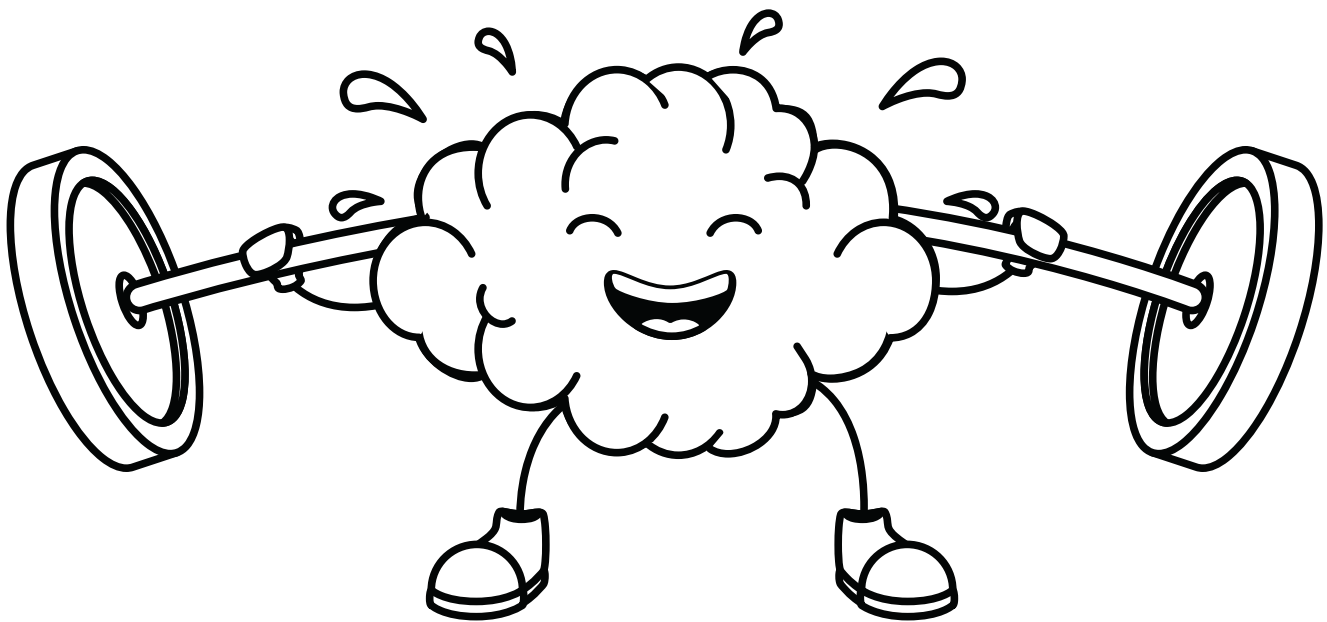

# Word Search

Circle the hidden words in the puzzle below!

E U R U Q H T O C T P G F R Y B M I B G H L I L P  
Z L V V W X E I B S T R A T E G Y O P K K M V E W  
T Y E F U T M R T G V G A P L T H Z E W H R P U Q  
U D A L V J F I W G L I D C Z B J H M E E A F Q P  
Y O X M L D S F S V Y B V A A Q K B M Y U Z H M S  
T V U O W D Q M O S B V L P Q W R C H I Q S V B B  
I S F M I W Y V N H I F L T U K X T F J X N Z G O  
A E T W D C O Z A N R L B A K J H F T K A K H A L  
L P G T L E Y Z V Z F G E I M A R W M W L M I R X  
U X Q V P Q Q V U Q Z G O N V R F U Z R Q V C R Z  
E C W V A T I B A Z M I V U U H S A S T Y G B V A  
G Z N Z M W Z H Q I M T Z O W E J O H S D N M W L  
I O C K I X O H G Y R I I R K A D M C P G Y L V O  
Q G E E W Z T F C L Q B F V E D V O C D K K Y Q I  
T F V E C F K M K U B W O L R N X X P Q U Y T H X  
Z B B T C I Y H L A D I P R Q P Z A A Y K Z C C N  
V O M R S W B E A K Z I Y C N T U I Y E R Y F T H  
R J P W J O J F C K P P C G Q E G F X Z Y V G C E  
P Q K Z R J I A P W J D M N G L I V A V Z L Q F R  
R L U L X V U C W Y V K T B L U H U G K Y C H I O

## WORD BANK

MISSILE

STRATEGY

JARHEAD

HERO

AIRBORNE

CAPTAIN

## Coloring Fun !

Color the picture while reading the affirmation aloud!

I bring energy and  
love to my family.

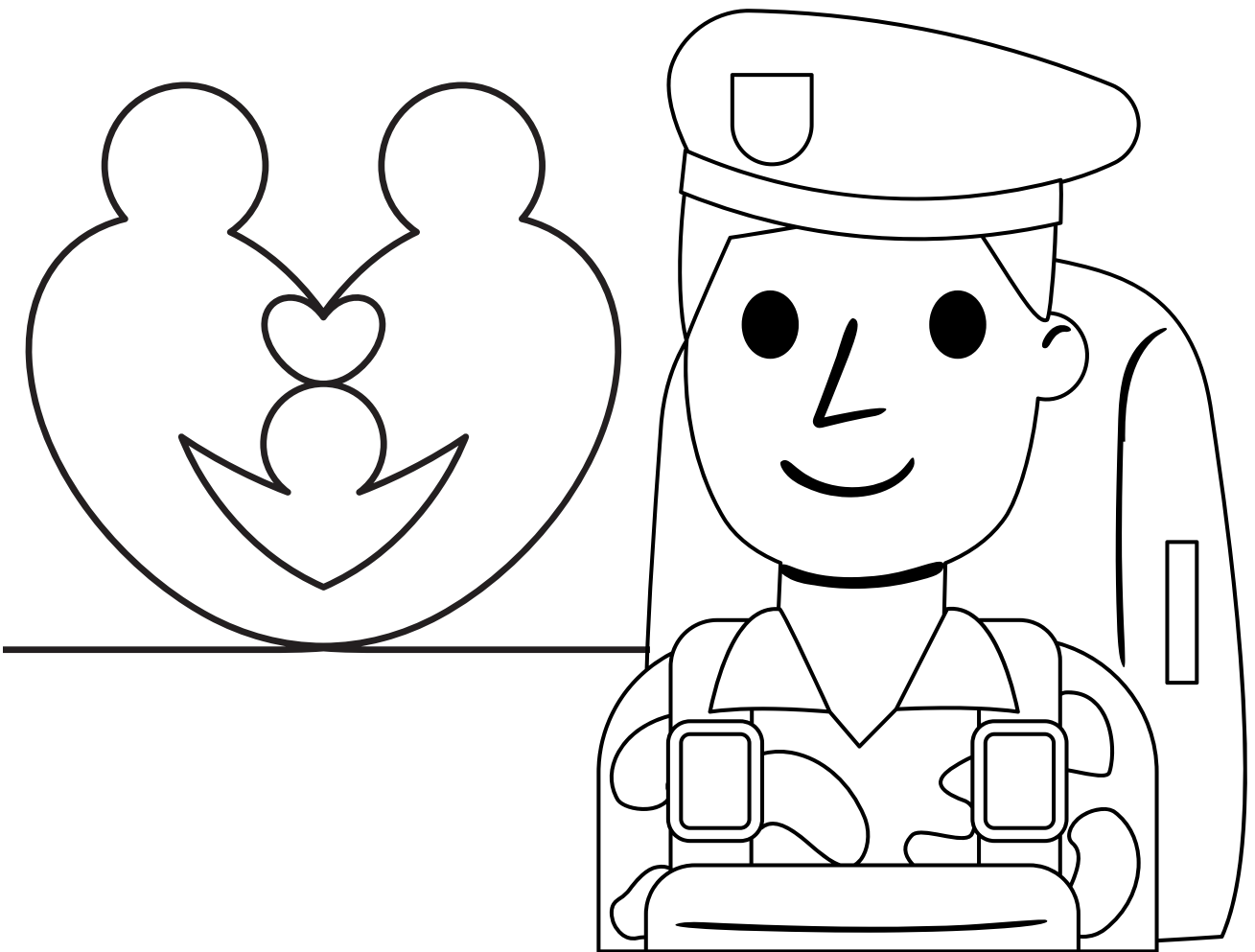

## Coloring Fun !

Color the picture while reading the affirmation aloud!

The country is  
thankful for my  
hero and me.

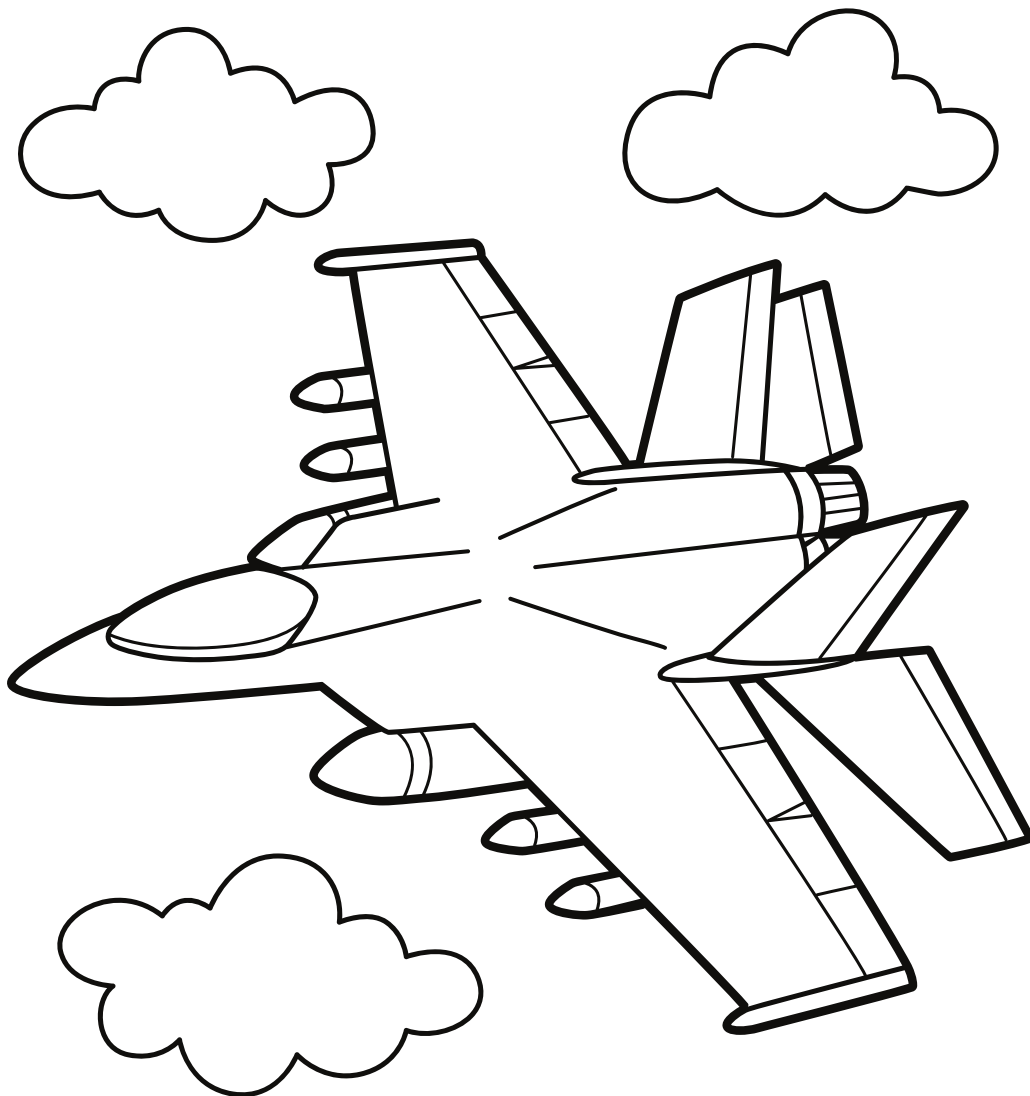

# Journaling

**A message to my hero for when they return...**

---

---

---

---

---

---

---

---

---

---

**Draw here.**

## Coloring Fun !

Color the picture while reading the affirmation aloud!

I am a warrior and  
a member of a  
team.

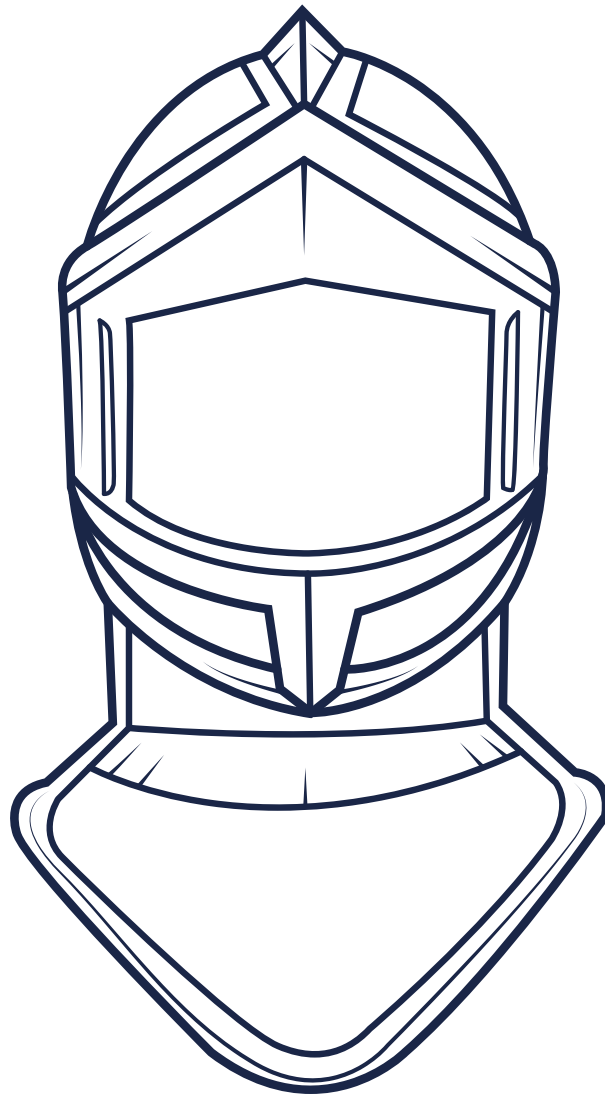

## Coloring Fun !

Color the picture while reading the affirmation aloud!

My family and I  
stand up for what  
we believe in.

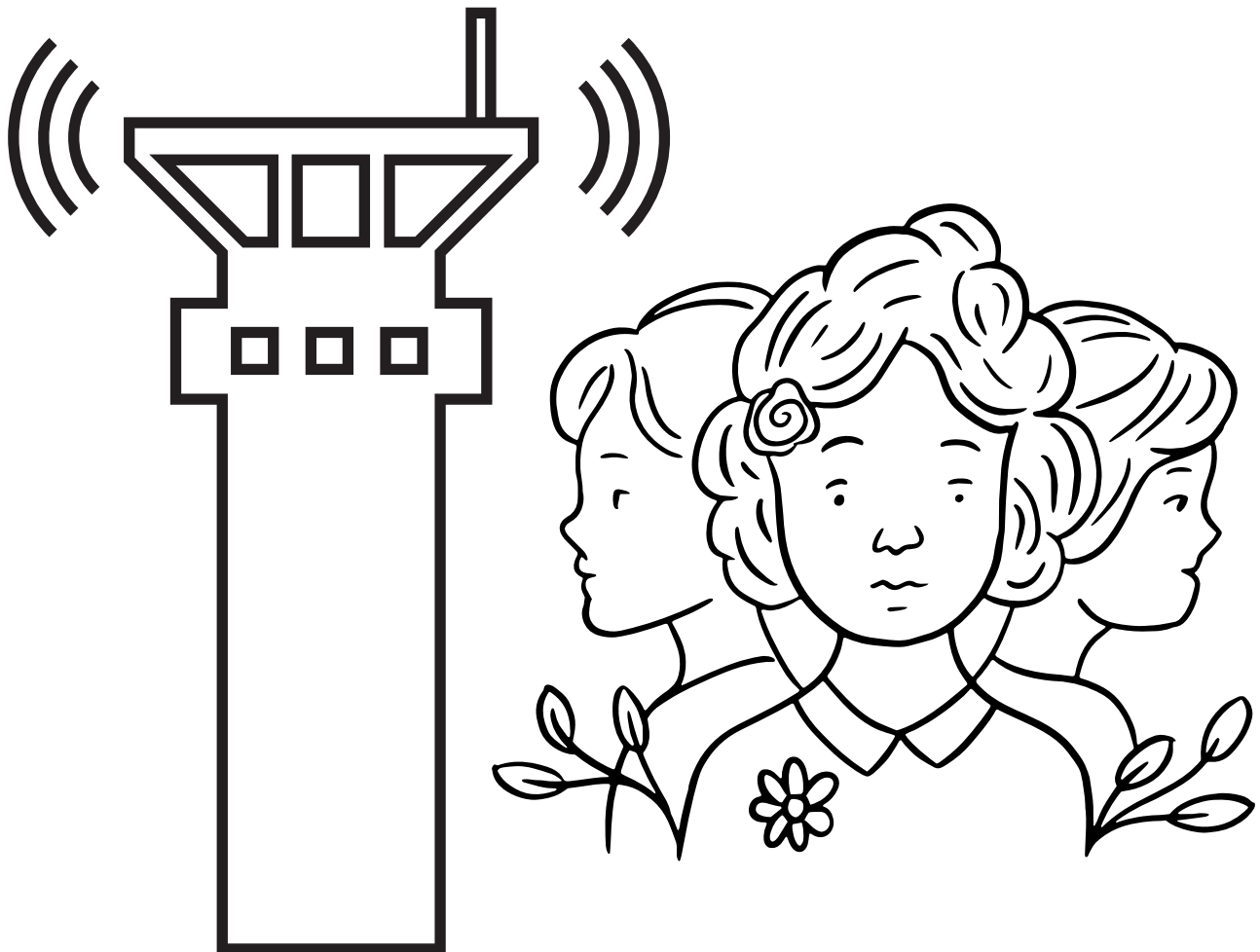



# Maze Fun !

Help the troops find the tank.

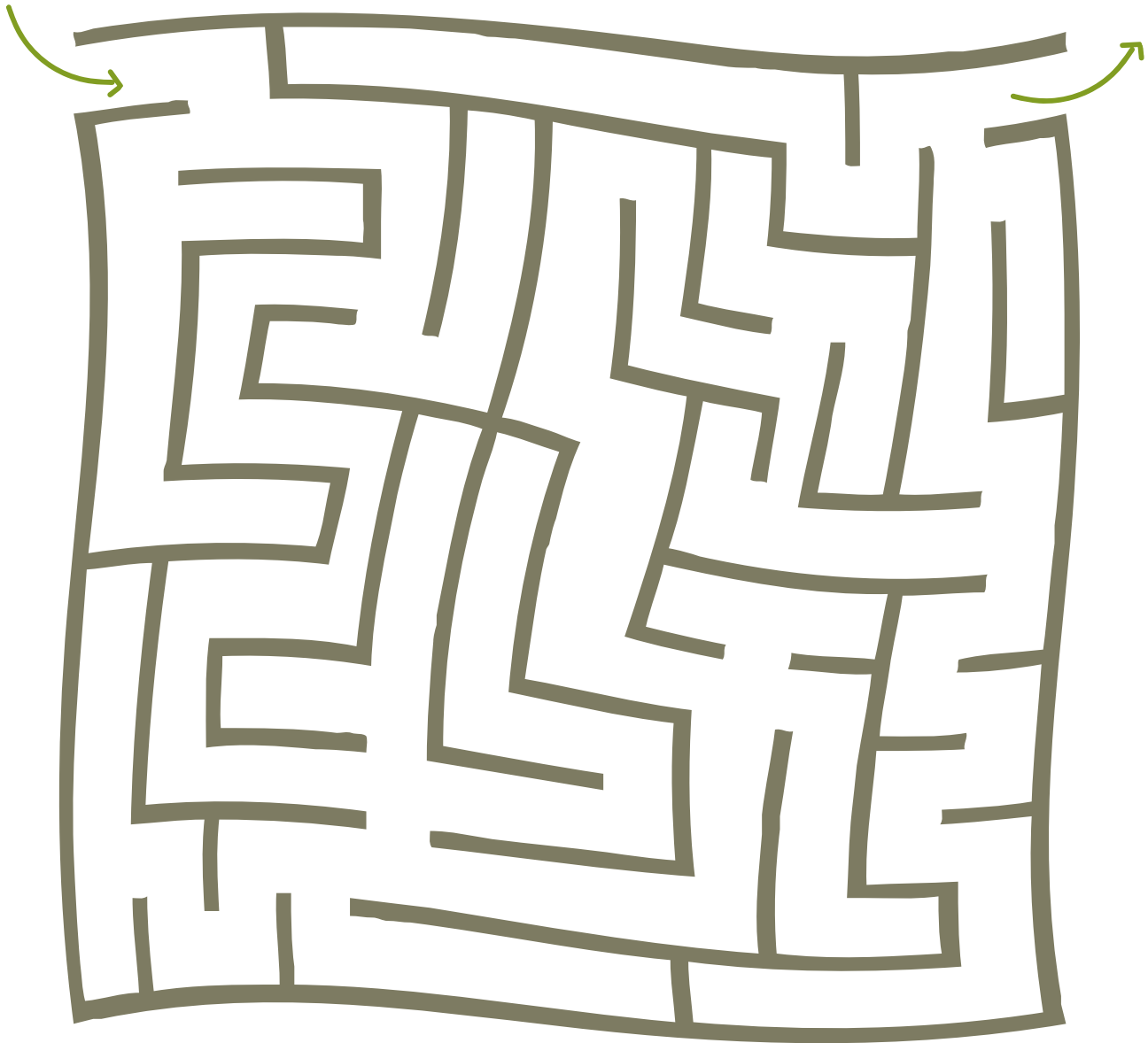

## Coloring Fun !

Color the picture while reading the affirmation aloud!

It's okay to feel all  
of these feelings,  
it's okay to feel  
scared about my  
hero.



## Coloring Fun !

Color the picture while reading the affirmation aloud!

My hero is brave  
and I am brave  
too.

Be Brave



# Word Search

Circle the hidden words in the puzzle below!

K R A E L V E L E H Y X W J F R U N P Z M E Q P B  
R G C E B B E M Q F O N T V K V P T K I M W J G Y  
B E I X N L V J I K E Z V W A G F H Z I Y V C T X  
J U K I L R W F H R R P D Z Y C K O B T U W S J Q  
X K I J E K K N J X U W M R Q S U K O D Y A R M L  
L O M R B E B B J Z Q R B F U O T C T H P P J G S  
V B K U V S E C C F T K S V V X M P T H D B M R N  
N U M G K H H C O K Y N Q Y V E D C J V Z F Z U X  
Y T B M D P P K M F V P I I L S T C O O E U L M N  
Y X H I R S T Q P W S D E I W X A H B U F F P E G  
M I S S I O N H A Q K H Q H P J X D T A R R P T H  
R G V S H V I E S Z N Z D C H M F J M L P A Z T C  
G Y C W U F Y H S F M Q V M V M G K T Z X E G P C  
O Y Y G N N F D U G P V R R M V D H J E A Y A E Q  
G T Q S I T G Y D G S D T R C S P O B J R M F D R  
Y V E N F Q I V M R T P N Y W K V U Z W Y L Z O S  
R I U D O T V Z Z A V T E A M W O R K L S S G V A  
G K L I R F O Y R A M M L J B X S R Q J H J H L K  
K F X O M D Z J Q J F O R M A T I O N Y F V U K O  
Z A E P F W C M R A L M U Z V J I M P A M G W U H

## WORD BANK

COMPASS

UNIFORM

MISSION

FORMATION

COURAGE

TEAMWORK

## Coloring Fun !

Color the picture while reading the affirmation aloud!

I am a strong  
leader like my  
hero. My family can  
depend on me.



## Coloring Fun !

Color the picture while reading the affirmation aloud!

I am honest, brave,  
and strong.

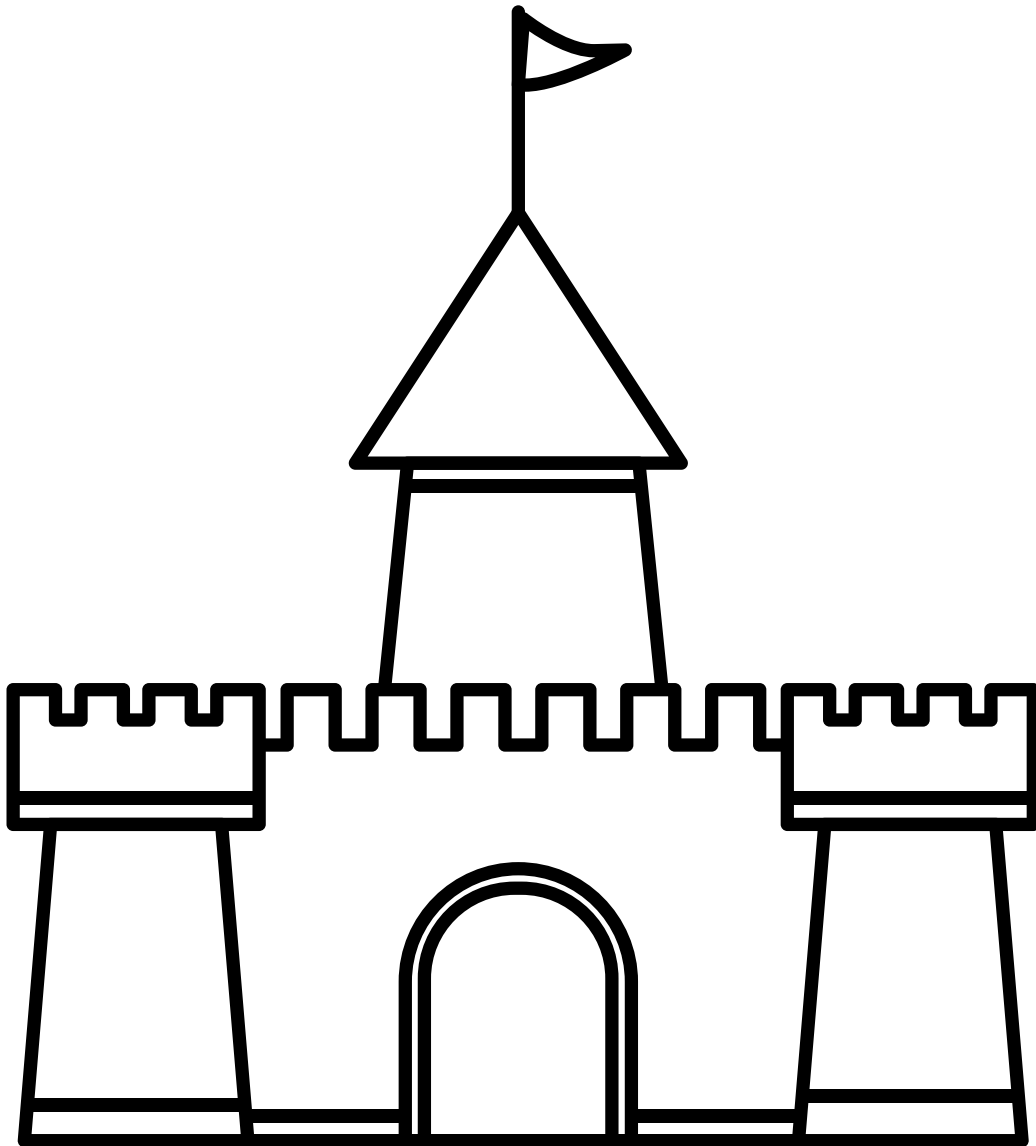

# Journaling

When I get upset or sad I will.....

---

---

---

---

---

---

---

---

Draw here.

## Coloring Fun !

Color the picture while reading the affirmation aloud!

I'll do an extra  
chore today, to  
make my hero  
proud.



Make  
Yourself  
Proud.



## Coloring Fun !

Color the picture while reading the affirmation aloud!

My hero is doing  
their best, I will do  
mine too.

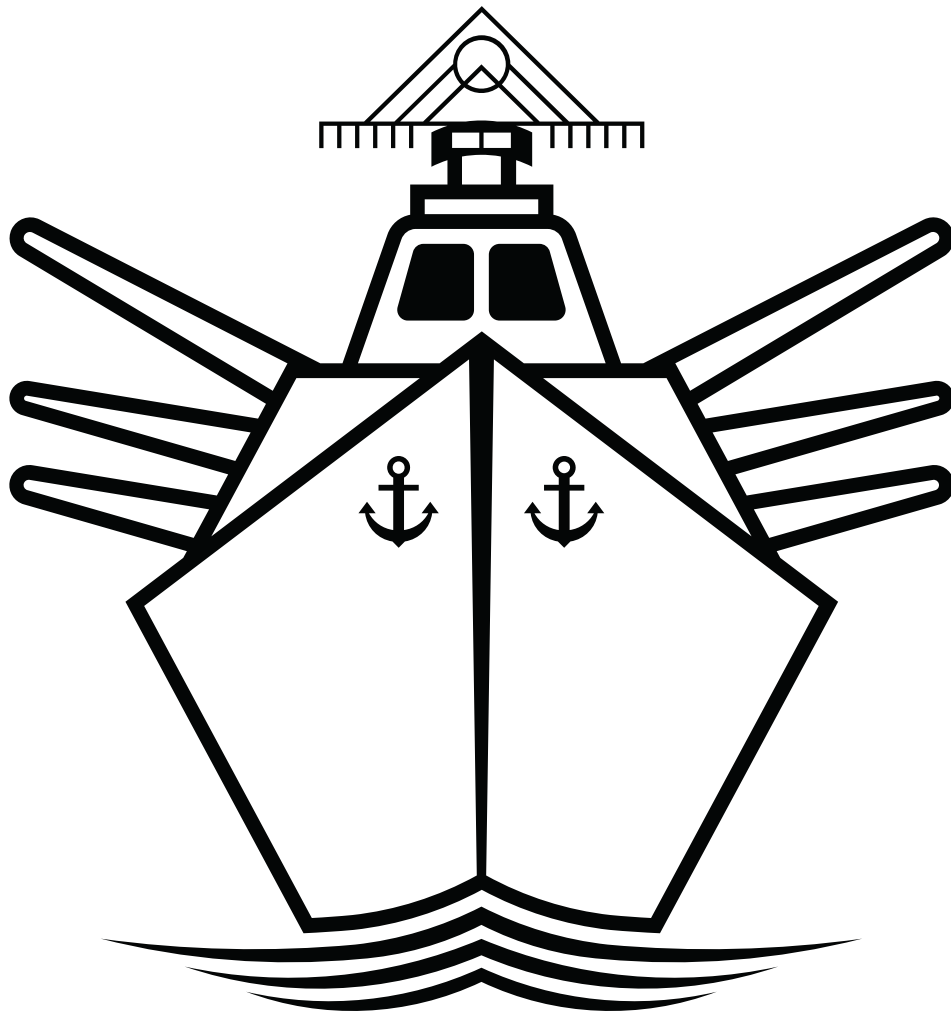

# Maze Fun !

Help the soldier find the flagpole.

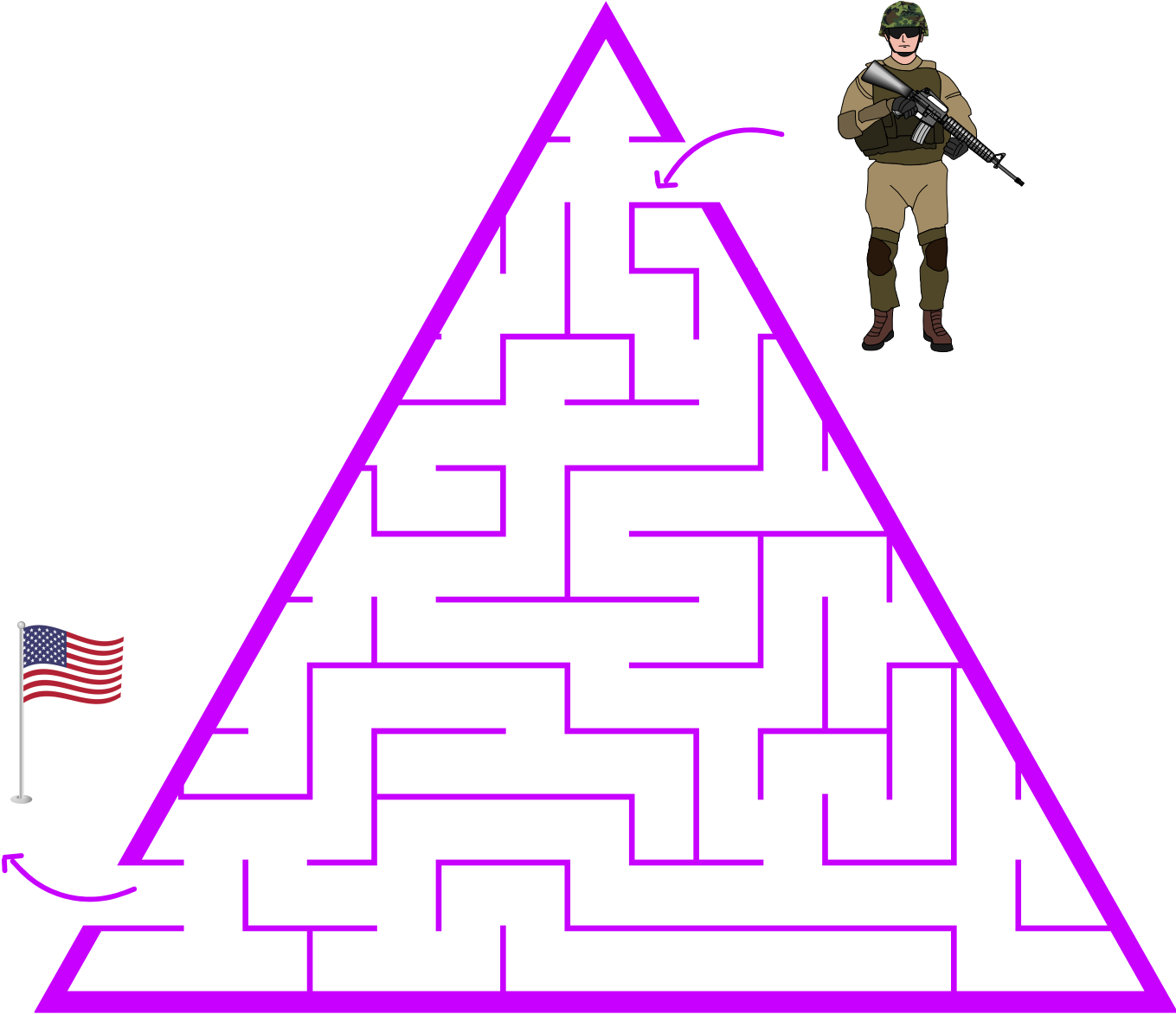

## Coloring Fun !

Color the picture while reading the affirmation aloud!

I'll get better with  
training and  
practice just like  
the military.

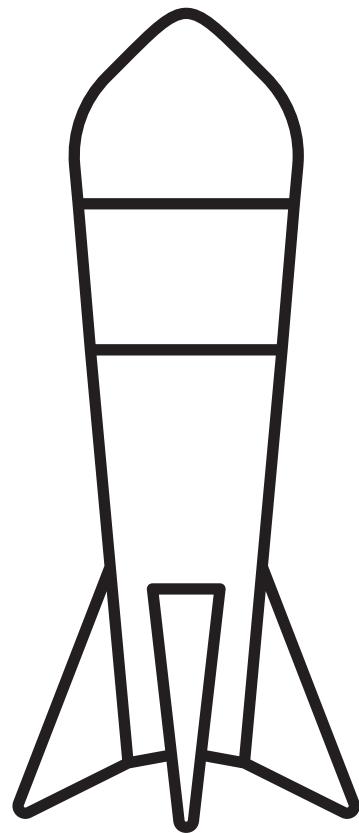
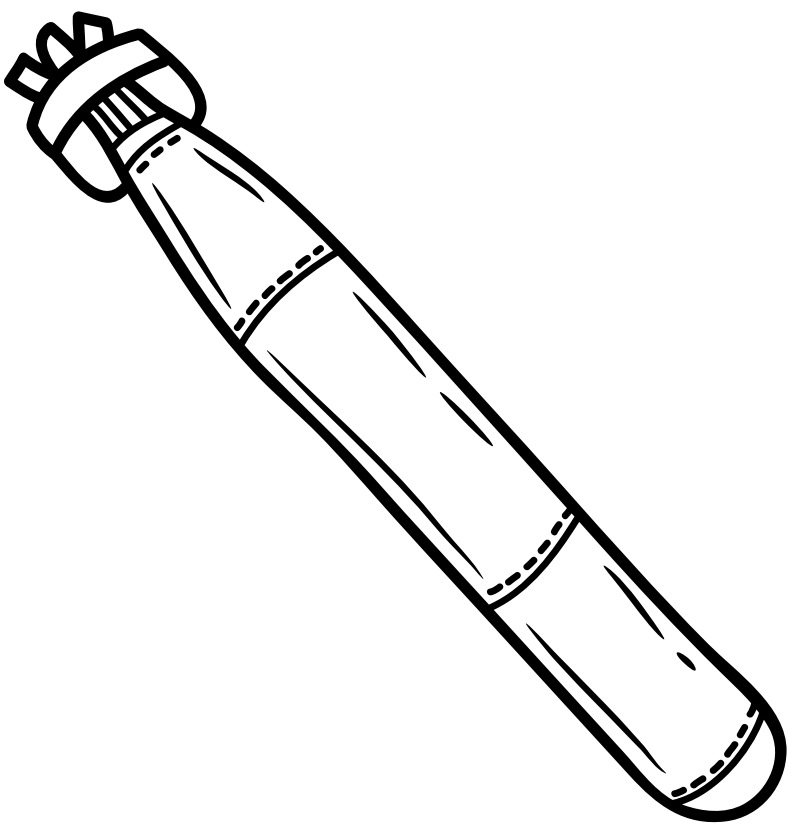

## Coloring Fun !

Color the picture while reading the affirmation aloud!

I love myself and  
my hero loves me.

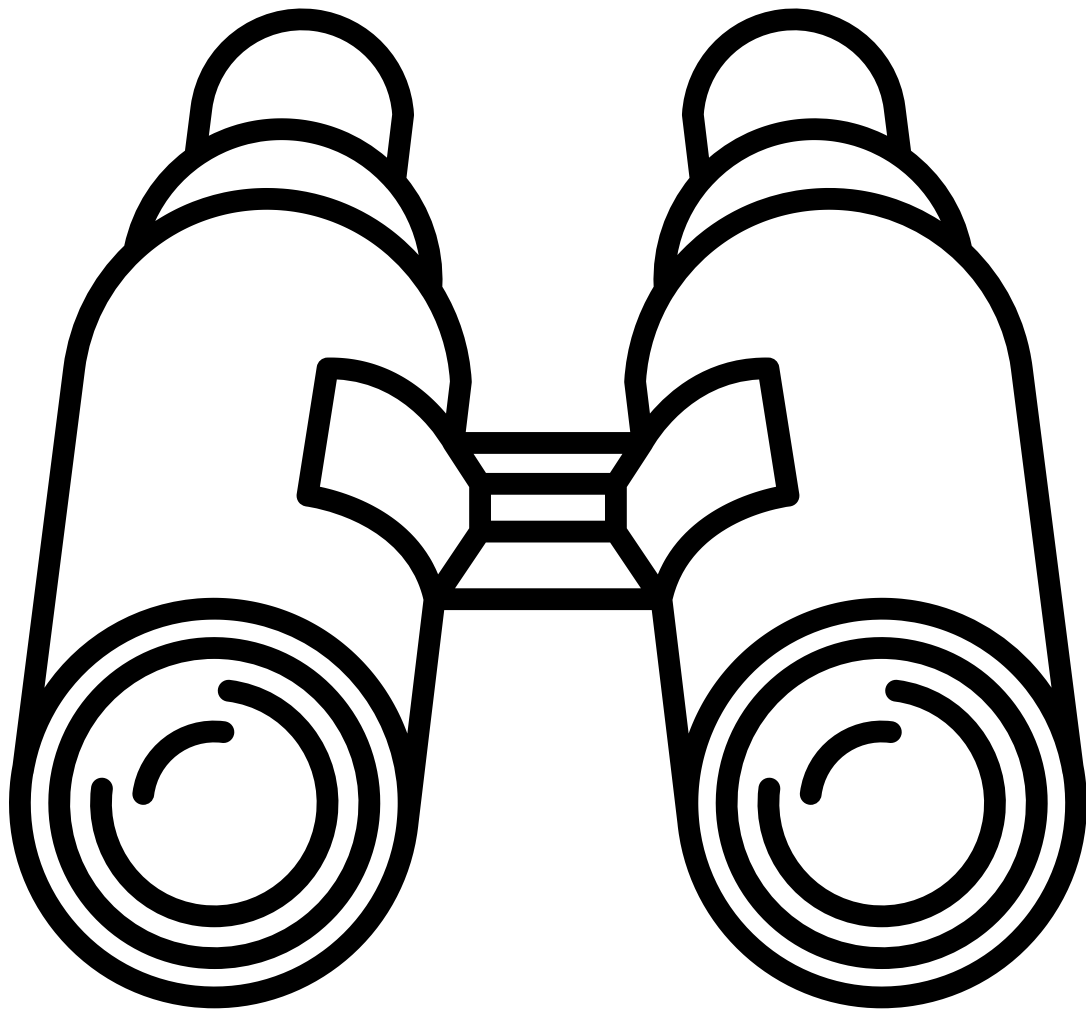

# Word Search

Circle the hidden words in the puzzle below!

E I M C C G V K G C Z N I G N Z D J G Q R H B H N  
E B X W C C W D A F E Y L R Z V O B G W T G I K B  
M A U R F E J W K Q I B I W J K W C R M H I Y Y O  
P I R Z G D W Q W B T M C P M G C W E I W Z K P B  
D H H U S C I N Q H H I X F A C X M S J V I H O Y  
M Q R B R A A H R L U E T S A Y S J I B A M R P Y  
J Y K T R R T W W K F T L B K V M J L R G C O B G  
E A F P A W L E U A F B I I G A G P I A U Y V Z R  
Y G V L E A D E R S H I P J C N P A E V Z O R W U  
K H M K H P S P P G U B P U Y O X I N E P A Q B V  
H H I F H P U Z O Y S N W I O O P A T J O R E Z E  
M B E Z D U B K K I Q Q R C X J V T Z I H L H C B  
D L O F C Y H E O A B Y S D W F K N E Z X I E N E  
S C L H U P H B B U R T T Y Z Y S N N R E B L F Y  
F J S F H O R S R F W H R W G X T Q K I K G M Q Z  
U G V P J K F W L E T V O E D W W W X G X H E T L  
W E X Y M X L U H Y F Q N G B M X U Y Y B M T Z U  
X W U W L V X T X S W C G L O Y F T Y R R I M W L  
G U T U U J P L O R O X B W C H S O N U S C E M O  
X U R L Y O B A Q V E P A C F E K J V E X J X U Q

## WORD BANK

HELICOPTER

BRAVE

RESILIENT

HELMET

STRONG

LEADERSHIP

## Coloring Fun !

Color the picture while reading the affirmation aloud!

Standing up for  
what's right and  
wrong is very  
important.

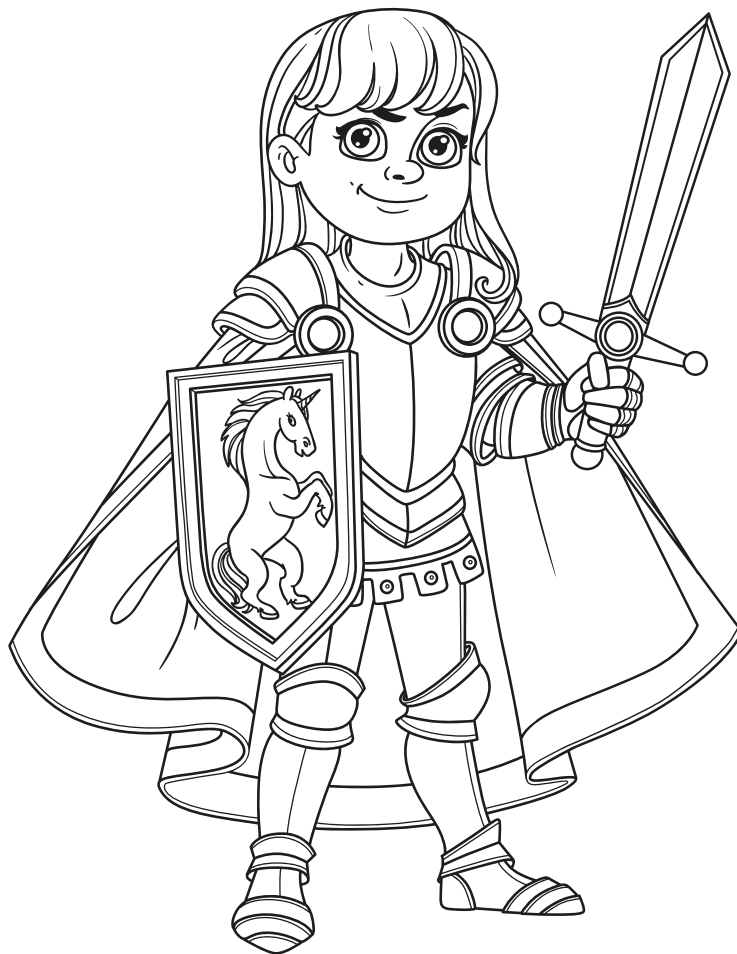

## Coloring Fun !

Color the picture while reading the affirmation aloud!

Even if I feel  
lonely, I'm never  
alone. Love is  
always with me.

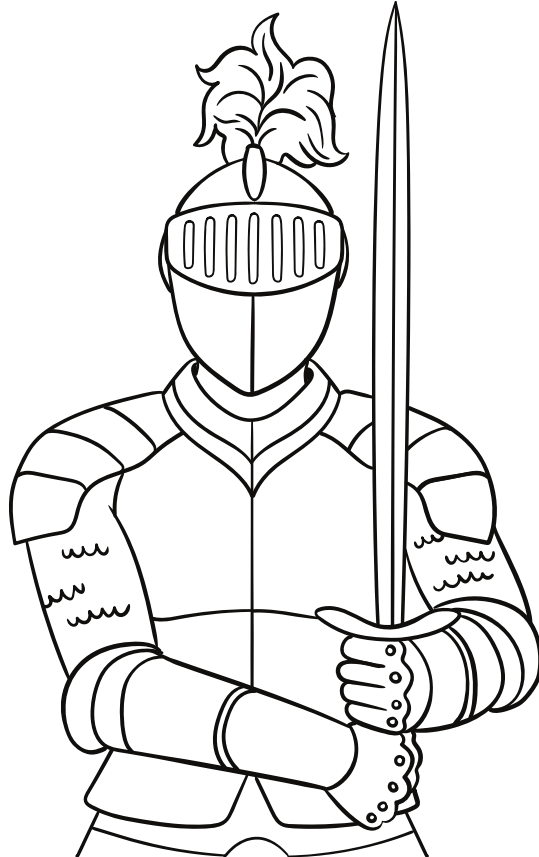

# Journaling

I'm proud of myself today because....

---

---

---

---

---

---

---

---

Draw here.



## Coloring Fun !

Color the picture while reading the affirmation aloud!

I'll make the world  
a better place  
today, like my hero  
does.

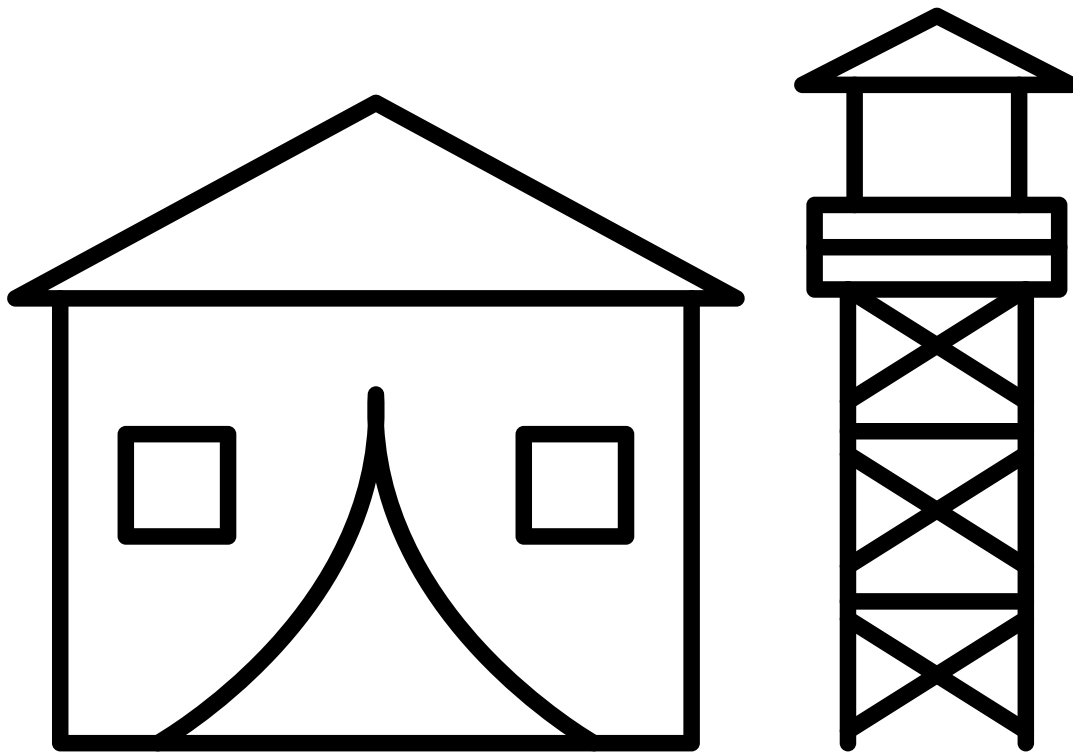

## Coloring Fun !

Color the picture while reading the affirmation aloud!

I want to be  
military strong,  
inside and out.



# Maze Fun !

Guide the helicopter to its landing spot.

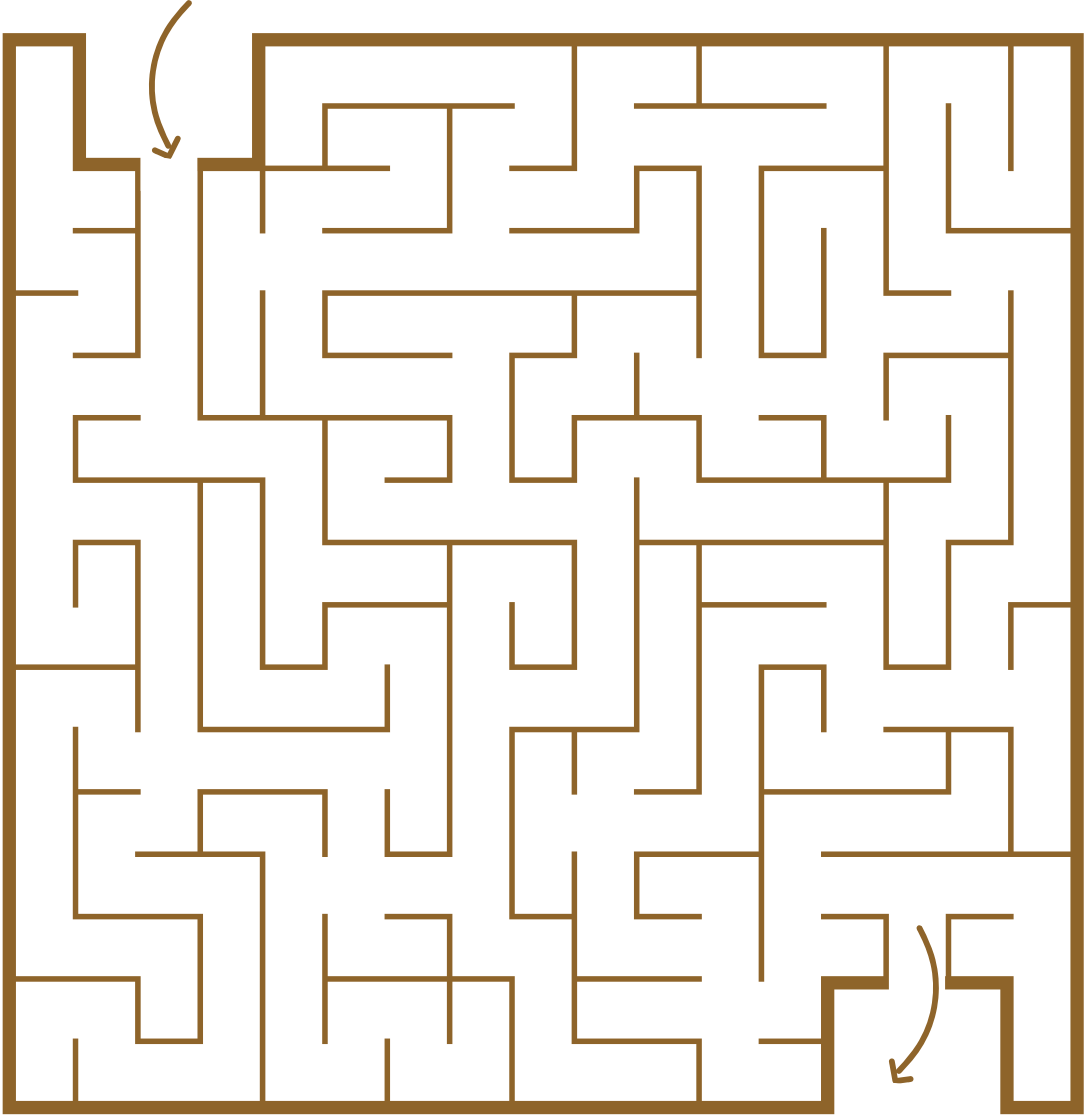

## Coloring Fun !

Color the picture while reading the affirmation aloud!

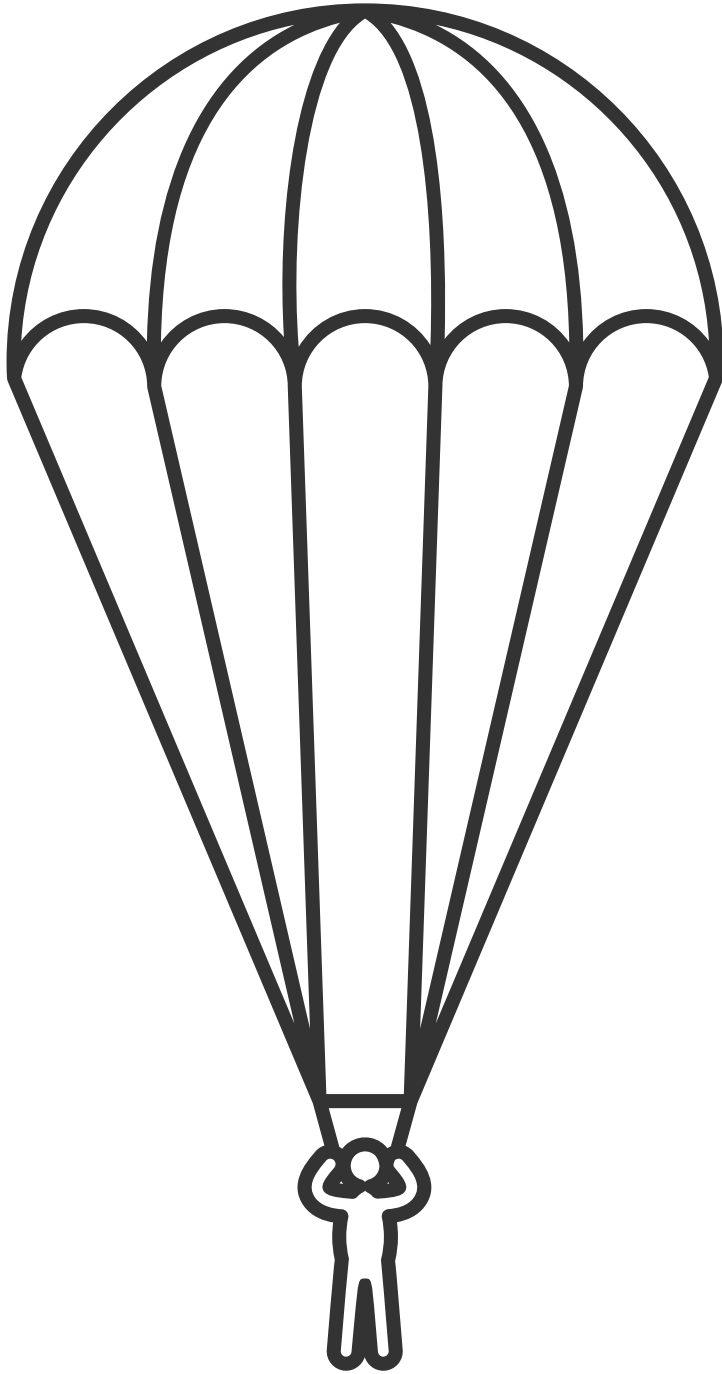

I am  
the  
future.  
The  
future  
of my  
family  
and  
this  
country.

## Coloring Fun !

Color the picture while reading the affirmation aloud!

I will tell my hero  
good news today.

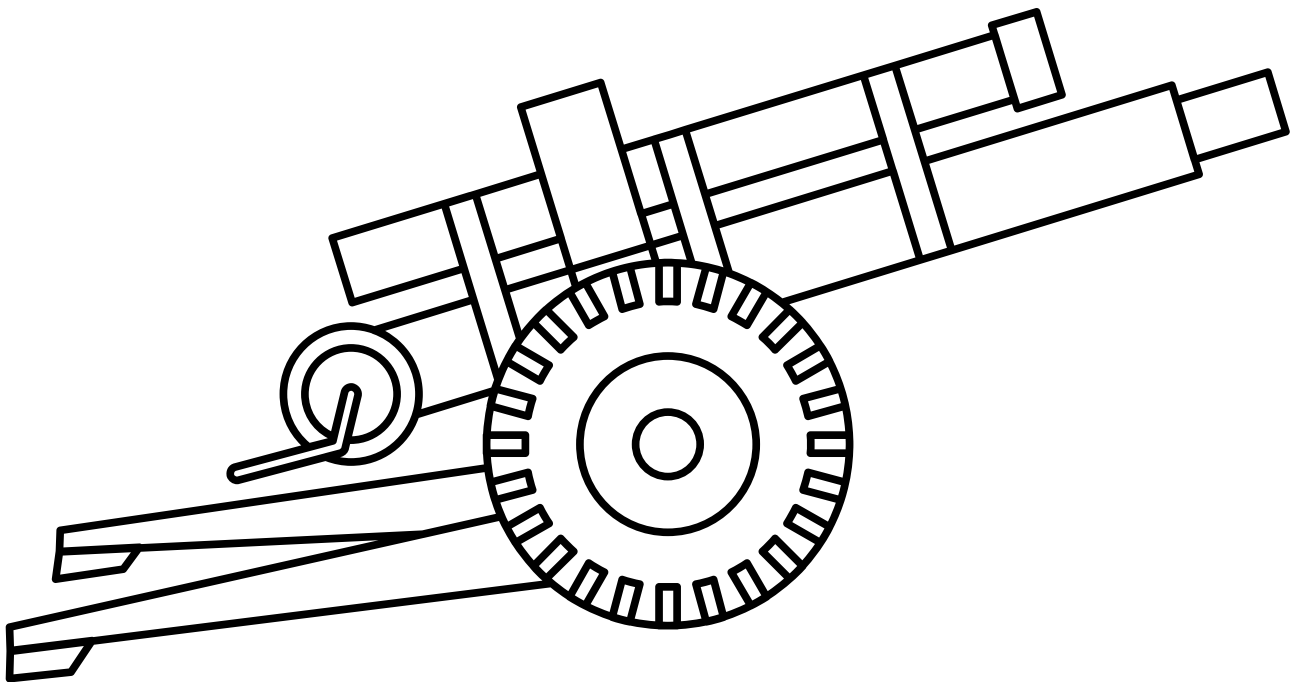

# Word Search

Circle the hidden words in the puzzle below!

P W L H Q A S J D L K V B H E Y X D S E C M U V I  
N P T A V E N W G L S R M R R Q J N C N M O B H U  
C J H L Z P S U W G C V J G N O Z Q E A I X Q K X  
T G W C J J C A N B C R A R I F Z D V F L H W R H  
C U G O K R B K H S B N W D M H J J A O I G K E L  
F D U R C K B D C H W U A V M K C H Q H T Q Q Q T  
A H W N H F N I U R N C O I R C J Z A K A M W Q V  
Z W S V P U R A G G C I K S F E D V Z M R H I W N  
P Y O B V Z I W V T U W X D V G X O N M Y M H E A  
L R F U G U C K W Y Q L E G J G C E X H T A A M C  
S F I S E R G E A N T Y P X G K S F P V O R T D Y  
E W C A S C Y C G X L E S A O G C A V B L I E E Q  
H W T W P Q U P I Z B R F Z R I I T O F Q N P K Y  
W Z Z B X Y T C T R U E M S P M W M X X K E G M K  
K H F M Y G O G T T T L F F N C Y Y R F J S C V O  
U N N B H A D E X M J Y U A J C E J B B D O J U K  
D C T W G W G T Q S T V L C I B L O G G O P B P A  
B V D E I G E T K I N A Y U K D P O R A G G S D A  
N A H A B X W M T Q O R N O U R R P J A V N B Q T  
K F Z B Z W H E G Q T A Q K M D I L P C E Z N Z F

## WORD BANK

MILITARY

NAVY

SERGEANT

ARMY

MARINES

TANK

## Coloring Fun !

Color the picture while reading the affirmation aloud!

I'll volunteer to  
help today, just  
like my hero  
volunteered.

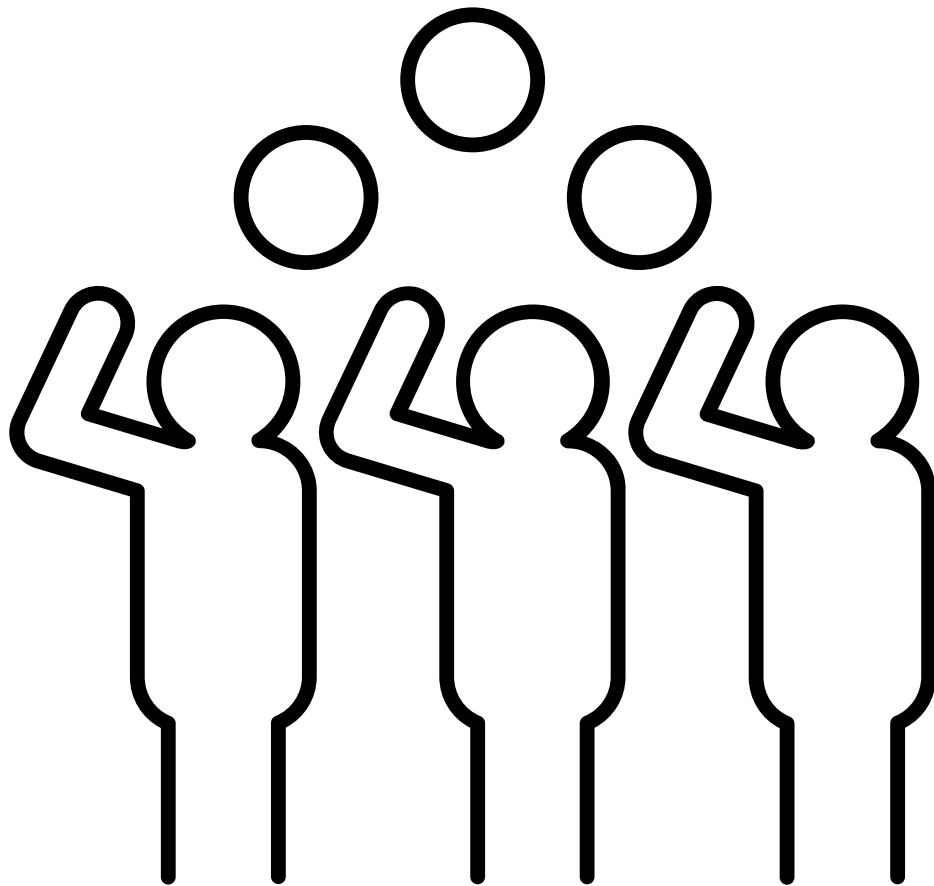

## Coloring Fun !

Color the picture while reading the affirmation aloud!

My mission is to  
help, protect and  
be good.

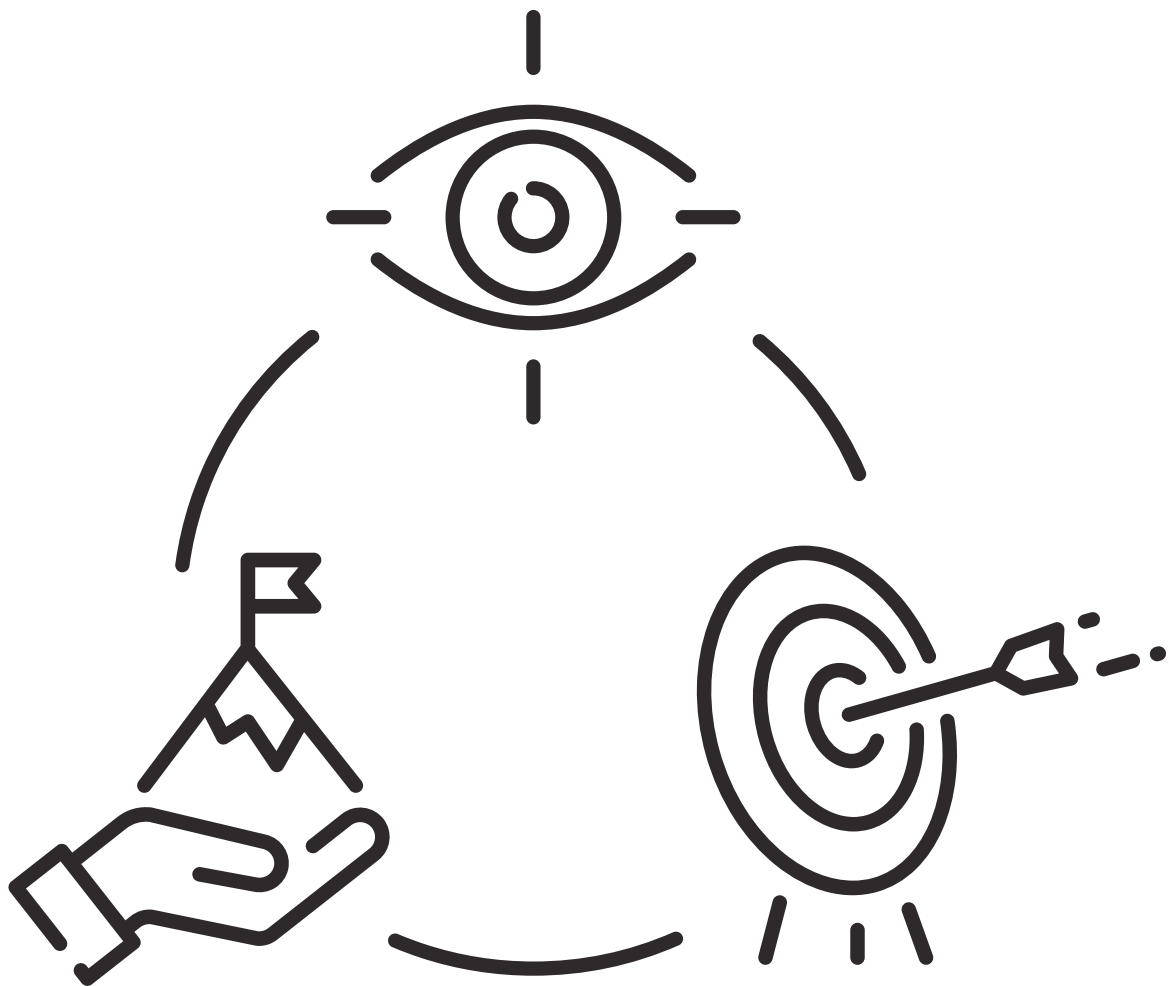



# Journaling

I love my hero because....

---

---

---

---

---

---

---

---

---

---

Draw here.

## Coloring Fun !

Color the picture while reading the affirmation aloud!

I'm part of the  
greatest team on  
earth.

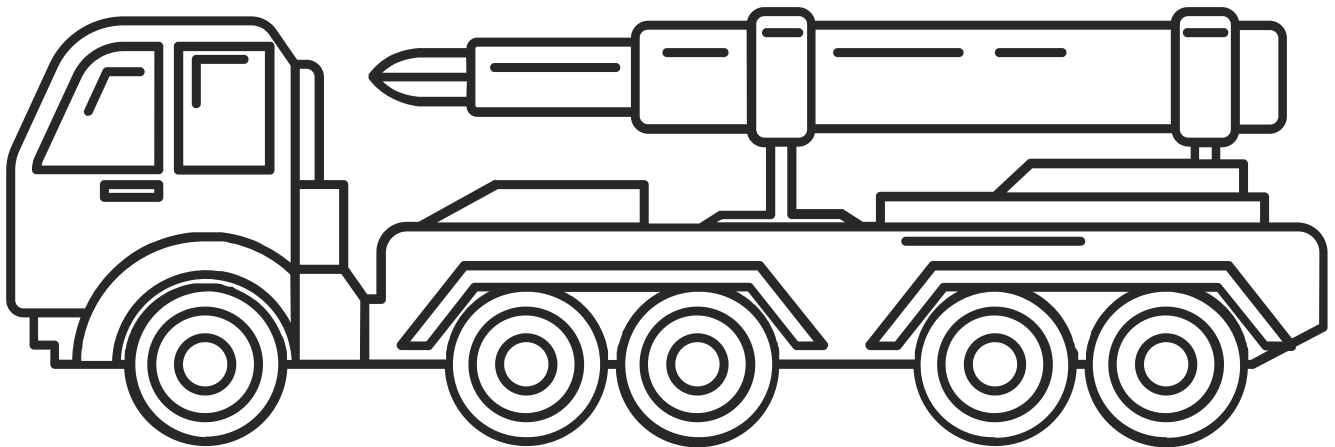

## Coloring Fun !

Color the picture while reading the affirmation aloud!

Like my hero, I  
never give up.

NEVER

• give up •

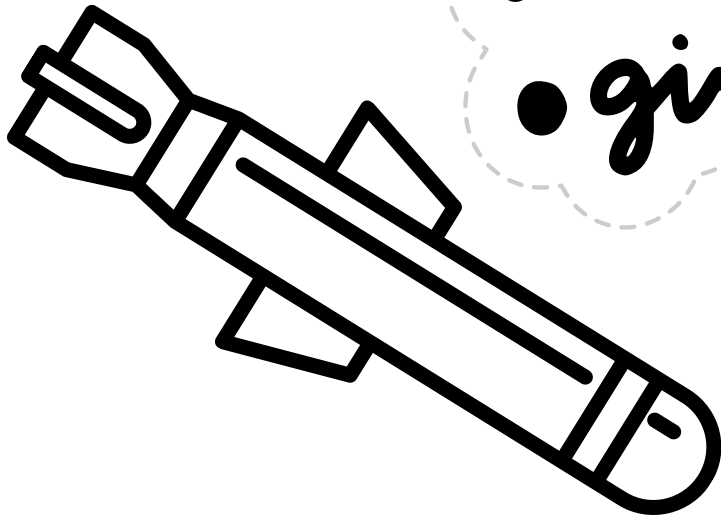

# Maze Fun !

Help the hero find his way to the tank.

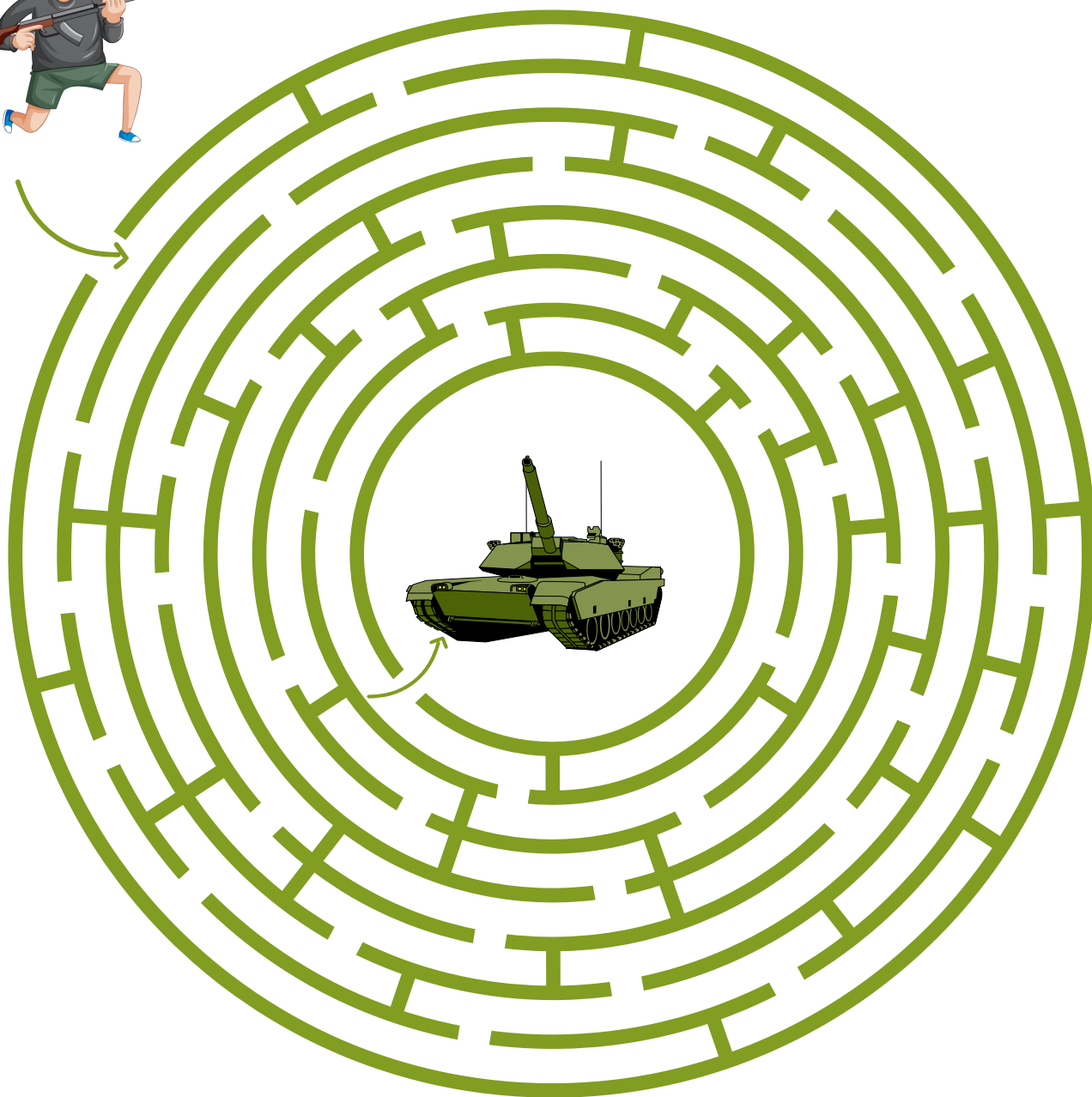

## Coloring Fun !

Color the picture while reading the affirmation aloud!

I'll make my hero  
laugh today.

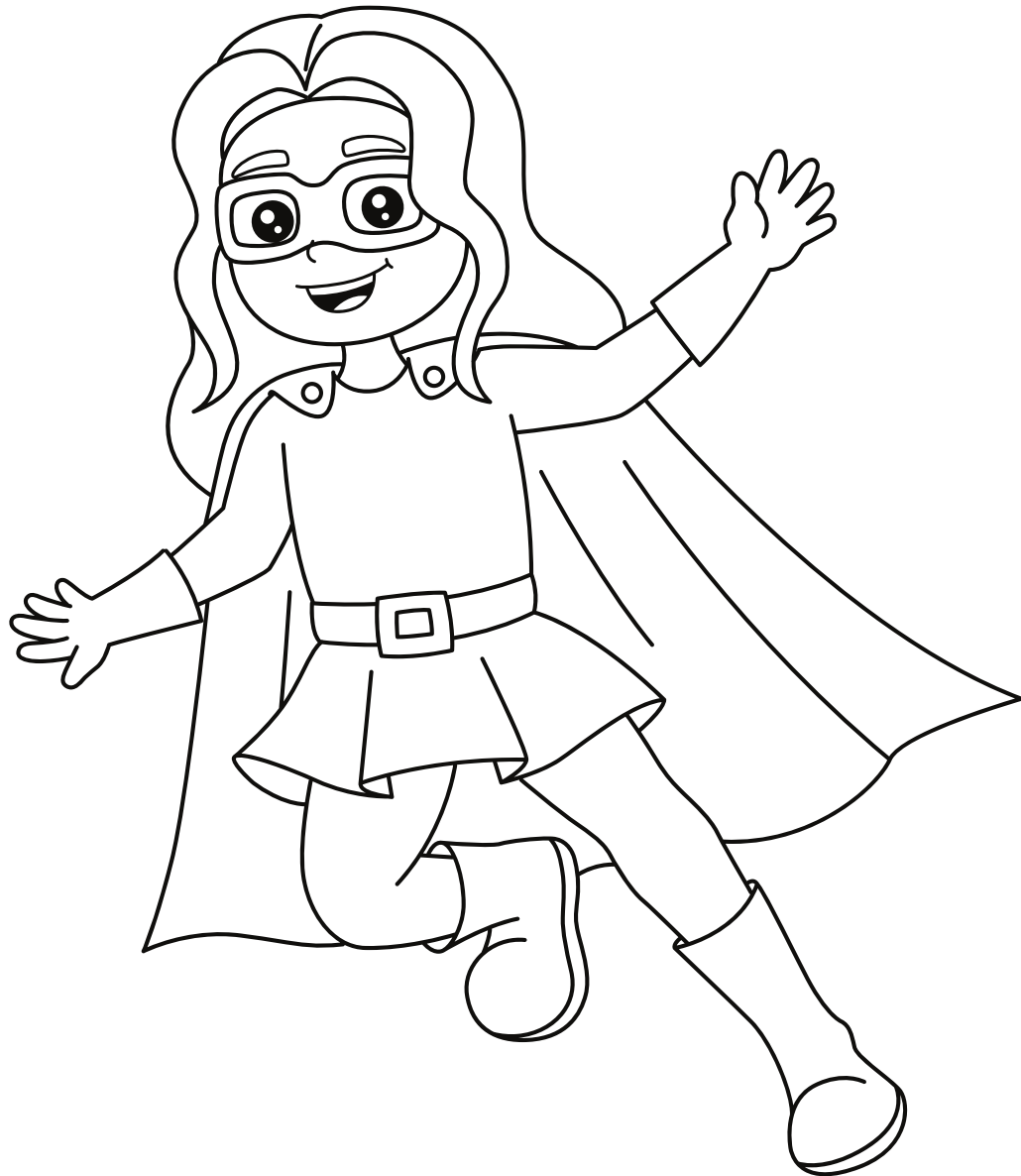

## Coloring Fun !

Color the picture while reading the affirmation aloud!

New places can be  
scary, but I have  
courage.



# Word Search

Circle the hidden words in the puzzle below!

Y Y E P L I X Q F Z M C T U V N O Q I E J X U L B  
Z Z V F Z Q V D X E U O I N V R R Q W K X K N Q X  
Q Z S E I Y U O E P N M Z Y J W W Z S N A Y G O E  
B P T I T X V V Q G I B M H E O A G Q D Z G O N Y  
I H I W E E A L E W T A L E Q M Y W Y M G R M N I  
R E V K E G R J U Y I T Z Z F H P S M Y O E E T N  
W C H K V X E A X F O Y D G C B E J F Q C P B C Z  
L H A R O J T H N O N P M T U F T J N F G U Q S E  
W H N L Z S W K X W S C R P G A S I V S H E W Y H  
U R S K T O L N U P A J I T E A I Y F R Q E B P U  
C P H N S Q L O N O B S O N Q M F H I W B M Z B V  
V Z Y A Q E S J E C G C O A F H X A E T O L Y R B  
B E X T O Q P P T H H P E T Q A L J H A G N F J L  
B T Y A A Z U X E I I M I F A J N B S E V Z P L G  
F J P J R C U C A K V V W O L N X T A V M Z K Q C  
W P M M I V T F I T T J U E B Z I O R O M B W O E  
Y L K L G B O I O I N O S G H L M Q U Y I G T T L  
V U C N A I Y W C L S X M I X V F V K T M G W I N  
T Z H D J B N M F A S K G C E M P A Q P H A R I P  
X U H C Z E C Y Z M L R M P U R G M I J Z Y N A G

## WORD BANK

VETERAN

MUNITIONS

SIEGE

TACTICAL

INFANTRYMAN

COMBAT

# Journaling

A funny and cherished memory with my hero is...

---

---

---

---

---

---

---

---

Draw here.



# Maze Fun !

Help the diver find the way to the submarine.

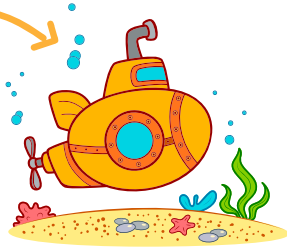
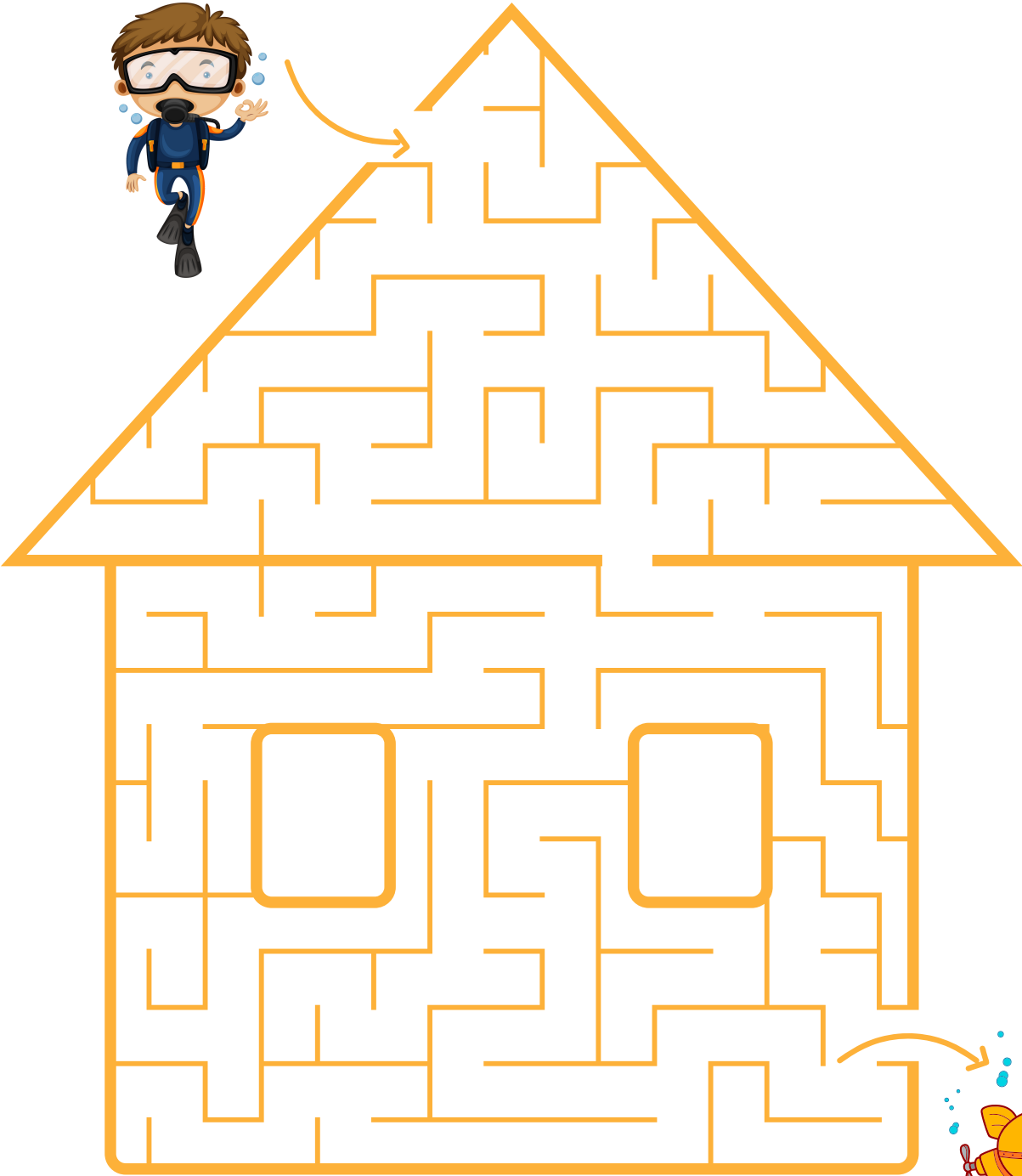

# Word Search

Circle the hidden words in the puzzle below!

U Y Z U Y E T L Y B P F C S S X P N N G O Q M A B  
H C O N K I W Y I M M K L F Z S K C K Q S I D S C  
J X L Q U S Y H N A O K O A F Y H J Z K H W E S U  
G H L M T M N N B Y R M N W K X H C A Q Y C B A P  
E W Q U O X U E D M T R E H J J U R F T P U N U H  
X T Z B C P Z H R N A U K K G F A Q I D H J P L N  
D G S Q L I H P S P R Q O B R H F C S O G L G T D  
Z E G B P K B Z R G L R G M Z D G F K P J L X M X  
O R P D H G Q D U K R A E Y T U R T F E M E W A M  
O B W L C U X T E Z I T T R C W Y V R L T U I H R  
C I Q G O A B G B C W M K O F C S D I G B D U C C  
N X N O I Y G R Z G G X O J O E V Q V J U Q U X G  
X G T L J T M V F G U U K N D N E Y O K K H W D U  
L P K C D G V E B G T O E H M D I R Q L H S E Z J  
S Q E I T H V K N H R B V R W I S V K O E O T M X  
R L Y H E Q P E J T M U B F R Q A W S B N Y B A K  
K E Z W N O C S O J G I A Y Q I Q I W Q G K Y E M  
I O E W C Q K K W L X H Y H Y U L Y K E C A T P G  
B A F W A H L Y Z Z N W X C V B A L H Q M V L J V  
L A S Y B U W Y U L T Q J R W O D M A D V B T Q H

## WORD BANK

DEPLOYMENT

PLATOON

ASSAULT

GUERRILLA

MORTAR

FLAK JACKET

# Maze Fun !

Help the soldier find his way to the aircraft.

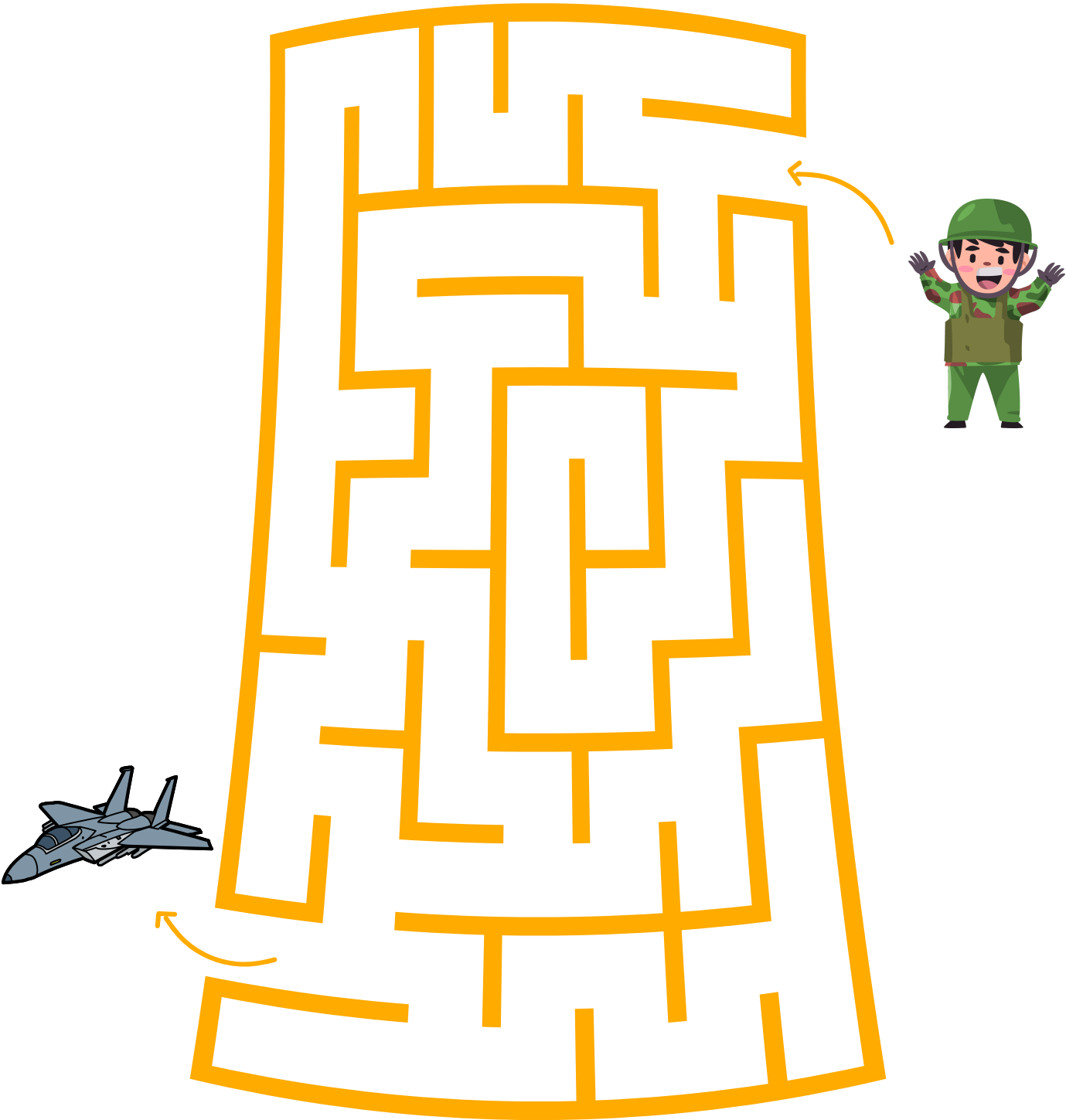

# Journaling

If I could talk to my hero right now, I would say...

---

---

---

---

---

---

---

---

Draw here.

**Answers  
Ahead!**



# Word Search

Circle the hidden words in the puzzle below!

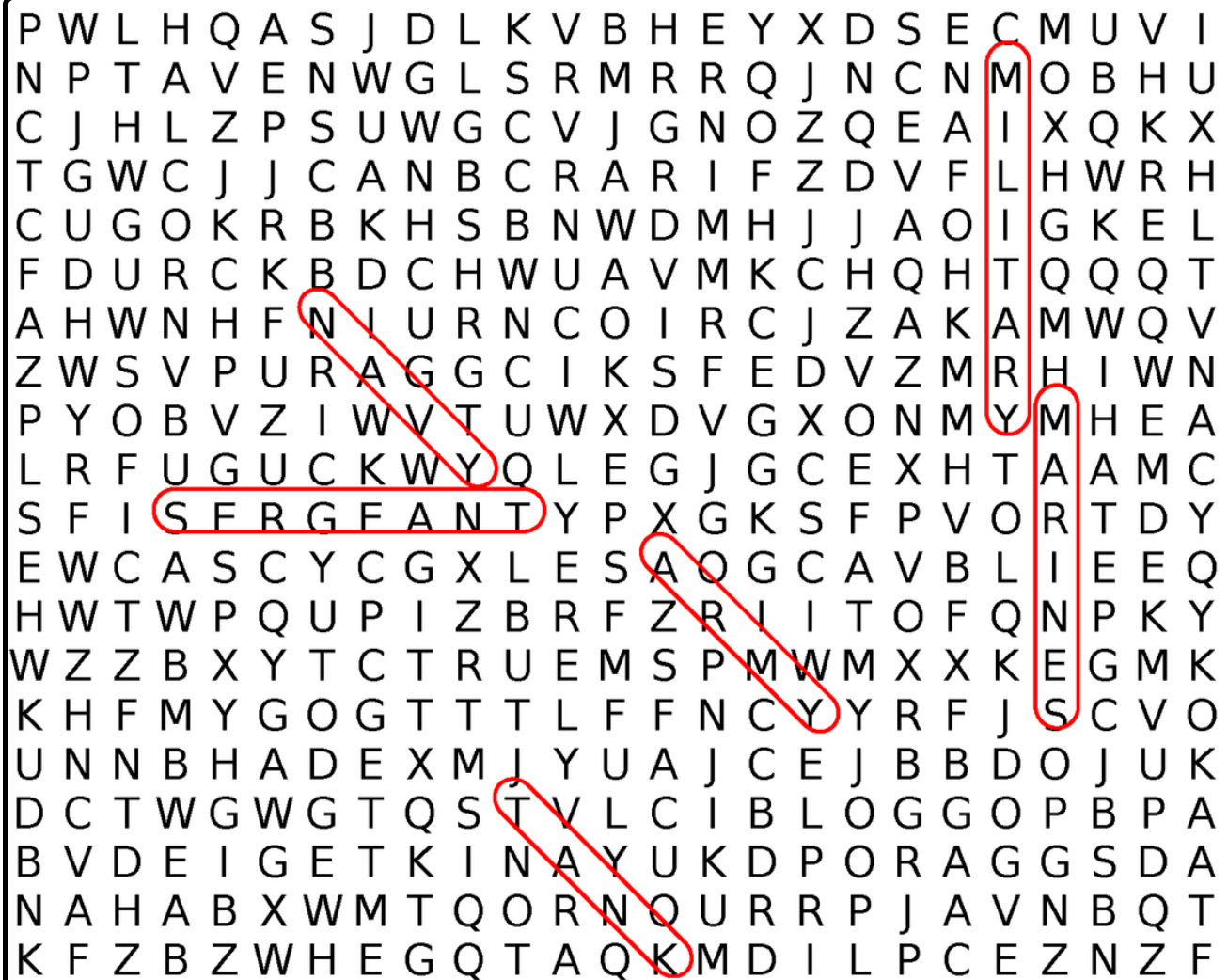

## WORD BANK

MILITARY

NAVY

SERGEANT

ARMY

MARINES

TANK

# Word Search

Circle the hidden words in the puzzle below!

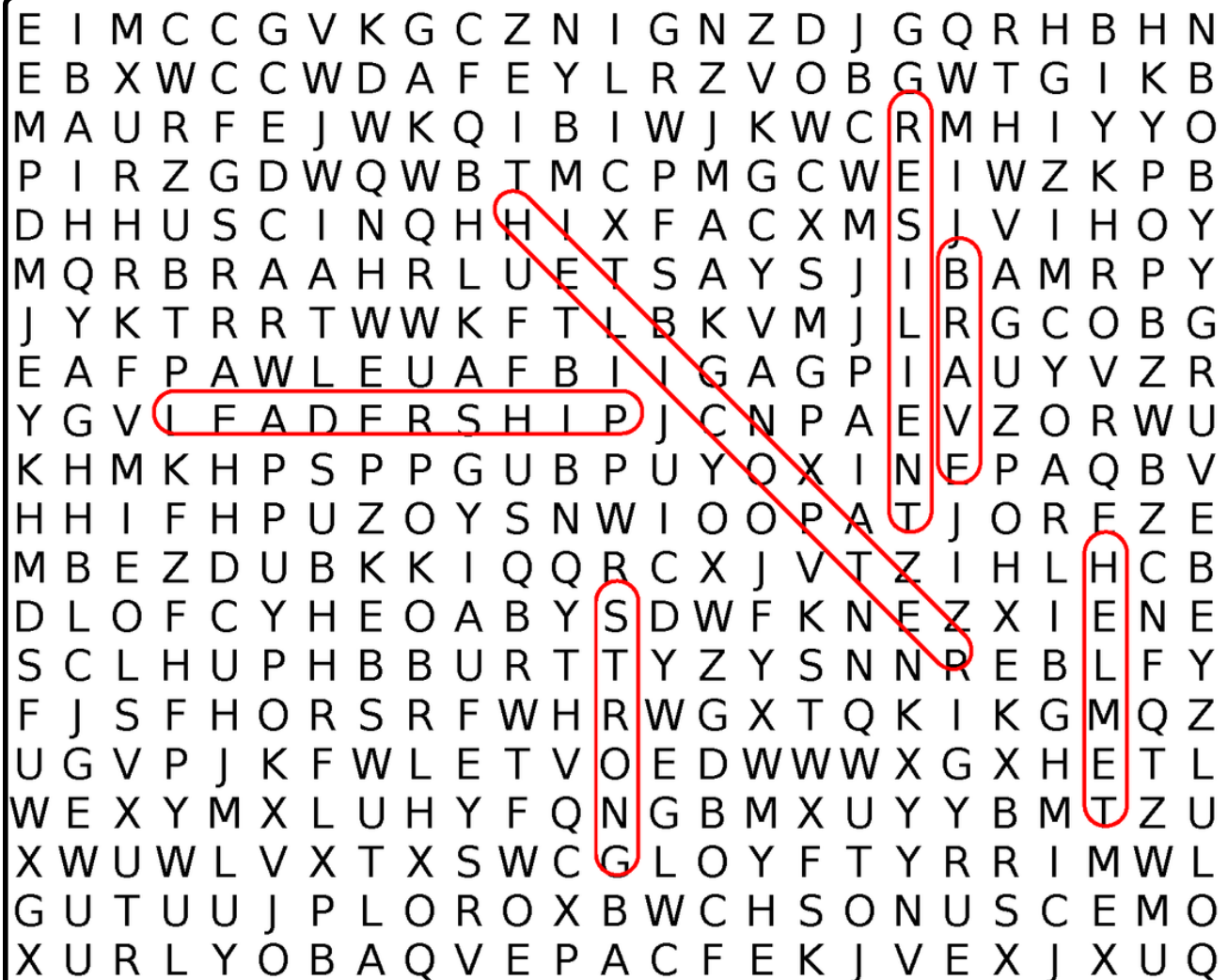

## WORD BANK

HELICOPTER

BRAVE

RESILIENT

HELMET

STRONG

LEADERSHIP

# Word Search

Circle the hidden words in the puzzle below!



## WORD BANK

COMPASS

UNIFORM

MISSION

FORMATION

COURAGE

TEAMWORK



# Word Search

Circle the hidden words in the puzzle below!



## WORD BANK

MISSILE

STRATEGY

JARHEAD

HERO

AIRBORNE

CAPTAIN

# Word Search

Circle the hidden words in the puzzle below!



## WORD BANK

INFANTRY

RADAR

CAMOUFLAGE

GENERAL

SUBMARINE

TOURNIQUET

# Word Search

Circle the hidden words in the puzzle below!



## WORD BANK

FORT

TORPEDO

MEDIC

BATTLESHIP

AIRCRAFT

RANGER

# Word Search

Circle the hidden words in the puzzle below!

Q V N X P J Y E W O K S K K A H G G M N V A Q D I  
J K R V E G C J V F R D F P T J R C X J U V Y F L  
L G U F J F D X A A E T D N V Q B B I R R T N N O  
L S U Q O E E O E A P E L G T V A O J C T U J O H  
Q Z V T X G C B J I C T G O Y W C N Y Z E Z G Q X  
V N J B U O J F U M C F S F X I O N D Q N S B O S  
Z E Q T D **B L A C K H A W K** S T M E H F B P X L V  
Y M X M R I R Z S X Y E Z O M T U L H O D R C V G  
J D D G V Q L N **P A R A C H U T E** N I Q J K S C Z  
E V Z D I W Z X P K C N L E O Q U R G W U C B K Z  
L R X N B Q W M R Y E N L D S A U O **C H I N O O K**  
J C Y O E F G T Y N C B X **S** B U B R T K G D C T O  
M F R M O G S Y D X Z T D O W Q D N K **S** E A V Z O  
V C D I C N W I Q X T G N L B V E O W N O D V C X  
T M I T T F I I Q G M C K D V A O I O I U N U A Q  
Q H D E G L A Y C Z H S E I F F X U V P U J B C J  
T Z C G D C I D E G L K B E R V X E O E W W F U H  
I T Q A M W H U M V N Z U **R** F P M K K **R** F R C A Q  
Q G T L X Z R O D N W G E K R Y O R H J O W F H P  
N B R Z K N C S J I I Q D F T G W S **A R M O R** C X

## WORD BANK

SNIPER

ARMOR

CHINOOK

SOLDIER

BLACKHAWK

PARACHUTE

# Word Search

Circle the hidden words in the puzzle below!

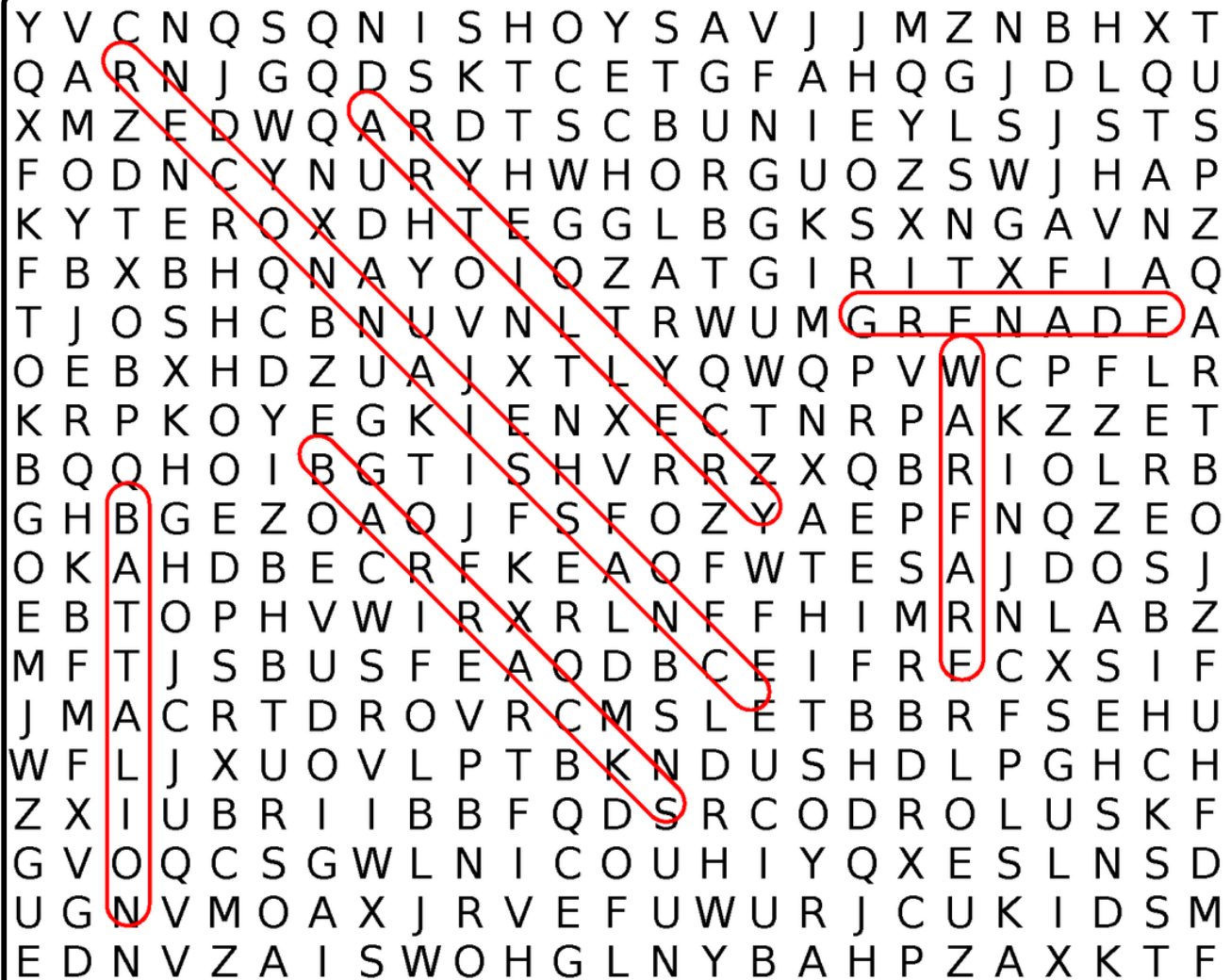

## WORD BANK

ARTILLERY

GRENADA

WARFARE

BATTALION

BARRACKS

RECONNAISSANCE

# Word Search

Circle the hidden words in the puzzle below!

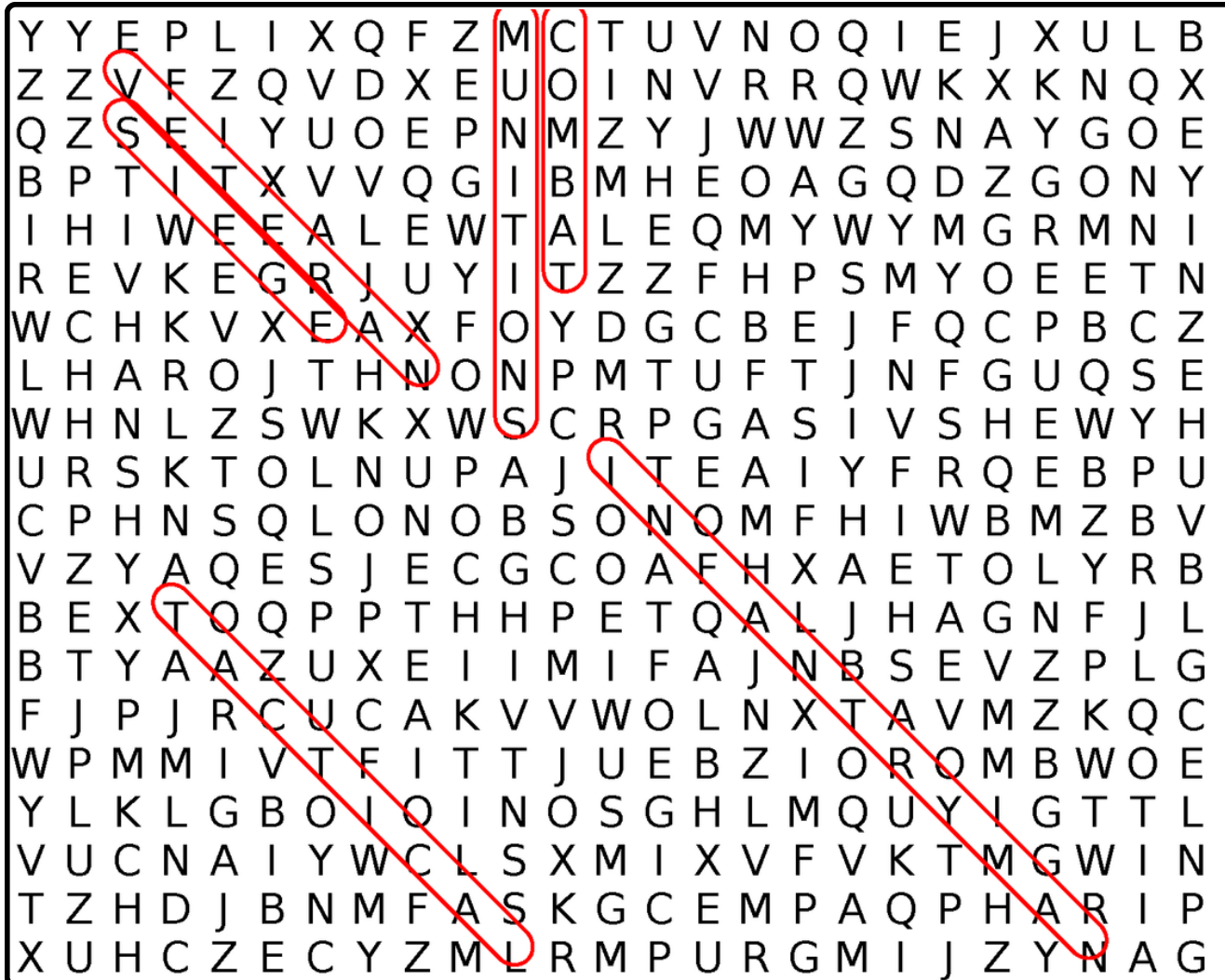

## WORD BANK

VETERAN

MUNITIONS

SIEGE

TACTICAL

INFANTRYMAN

COMBAT

# Word Search

Circle the hidden words in the puzzle below!



## WORD BANK

DEPLOYMENT

PLATOON

ASSAULT

GUERRILLA

MORTAR

FLAK JACKET



John is a combat veteran and author. He's served as an infantry squad leader in Afghanistan with the 101st Airborne. John has his bachelor's degree from St. Joseph's University in New York and his Masters from Harvard. He created the Combat To College Grow Method: A coaching program for student veterans and wrote the Veterans Guide To Moving Abroad. He's the author of Combat To College, 365 Days of Veteran Affirmations, and the #FreedomChallenge. John's spoken to congress as a legislative fellow and writes on his blog about veteran mental health.



[www.JohnHDavisWriter.com](http://www.JohnHDavisWriter.com)



@John.H.Davis.Writer



@Combat.Vet.Aboard

